

GREAT LAKES FISHERY COMMISSION
Research Completion Report *

COSTS OF FISHERIES REHABILITATION IN GREEN BAY AND THE BAY OF QUINTE

by

Brian W. Gould
Richard C. Bishop
*Department of Agricultural Economics
University of Wisconsin-Madison
Madison, Wisconsin 53706*

April, 1989

* Project completion reports of Commission-sponsored general research are made available to the Commission's cooperators in the interests of rapid dissemination of information which may be useful in Great Lakes Fishery management, research or administration. The reader should be aware that project completion reports have not been through a peer review process and that sponsorship of the project by the Commission does not necessarily imply that the findings or conclusions contained in the report are endorsed by the Commission.

Table of Contents

I.	Introduction	1
1.1	Description of Green Bay and The Bay of Quinte	2
1.1.1	Characteristics of Green Bay	2
1.1.2	Characteristics of the Bay of Quinte	5
II.	Historical Overview of Water Quality and the Fisheries of Southern Green Bay and the Lower Fox River	8
2.1	Overview of Commercial and Sport Fisheries in Southern Green Bay	9
2.1.1	Recent Changes in the Southern Green Bay Yellow Perch Fishery	11
2.1.2	Changes in the Commercial Catch of Other Native Species	17
2.1.3	Role of Exotic Species for Commercial Production in Southern Green Bay	19
2.1.4	Sport Fishing Activity in Southern Green Bay	21
2.1.5	1986-1991 Lake Management Fish Management Plan and Green Bay	26
2.1.6	Conclusion	28
2.2	Water Quality Conditions in Southern Green Bay	29
2.2.1	Direct Discharges by Point Sources into the Lower Fox River	31
2.2.2	The Level of Point Source Loadings of BOD and Suspended Solids into the Lower Fox River and Southern Green Bay	34
2.2.3	Point and Non-Point Loadings of Phosphorus into the Lower Fox River and Southern Green Bay	41
2.2.4	Loadings of PCBs and Other Substances into the Lower Fox River and Southern Green Bay	49
III.	Expenditures for Water Pollution Control By the Pulp and Paper Industry and Municipalities on the Lower Fox River	56
3.1	Expenditures for Water Pollution Control in the Fox River Region by the Pulp and Paper Industry	56
3.2	Past Expenditures for Waste Water Treatment by Municipalities On the Lower Fox River	60
3.3	Summary of Historical Expenditures for Point Source Water Pollution Control in the Lower Fox River Region	61
IV.	Review of RAP Rehabilitation Objectives for Southern Green Bay	65
4.1	Overview of the Fishery Related Objectives	65
4.2	Overview of Other Goals Associated with Rehabilitation	69
V.	Estimated Costs for the Rehabilitation of the Southern Green Bay Ecosystem	72
5.1	Costs of Phosphorus Reduction	72
5.2	Estimated Costs of Reducing Toxic Contaminants in Southern Green Bay	84
5.3	Costs of Fisheries Rehabilitation	85

5.3.1	Costs Associated with Fisheries Rehabilitation-Exotic Species	85
5.3.2	Costs of Fisheries Rehabilitation-Native Species	86
5.4	Total Capital and Operating Costs	88
VI.	Review of the Status of Fisheries and Water Quality in the Bay of Quinte	90
6.1	Description of the Commercial and Sport Fisheries of the Bay of Quinte	91
6.1.1	An Overview of Commercial Production in the Bay of Quinte	93
6.1.2	Value of Commercial Fish Production in the Bay of Quinte	103
6.1.3	Current Status of the Sport Fishery in the Bay of Quinte	109
6.2	Water Quality Conditions in the Bay of Quinte	111
6.2.1	Phosphorus Loadings in the Bay of Quinte	111
6.2.2	Nitrogen Loadings in the Bay of Quinte	135
6.2.3	The Presence of Toxic Substances in the Bay of Quinte . .	140
7.1	Key Concerns and Water Quality Goals for Rehabilitation of the Bay of Quinte	143
7.2	Costs of Reducing Point Source Loadings to the Bay of Quinte . .	145
7.3	On-Farm Costs of Reducing Agricultural Non-Point Phosphorous Loadings	147
VIII.	Conclusions	155
	Bibliography	158

List of Tables

<u>Table</u>	<u>Page</u>
1. Sport Fishing Harvest, 1983-1985, Southern Green Bay (number caught)	23
2. Level of Fish Stocking, Wisconsin Waters of Green Bay, 1978-1986 . . .	24
3. Cost of Stocking Lake Michigan Fish, 1985 Year Class	27
4. Total Costs of Stocking Green Bay, 1978-1986 (in current dollars) .	27
5. Average Discharge Rates of Water, Suspended Solids and Chlorides For Four Major Rivers Entering Green Bay, Early 1970's	31
6. Dissolved Oxygen Levels in Southern Green Bay, 1938-1982	36
7. Current and Projected Sources of Phosphorus Under Alternative Scenarios (pounds)	43
8. Mean Daily Loadings of BOD, TSS and Total Effluent by Green Bay Metropolitan Sewage District to the Lower Fox River, 1956-1986 . . .	49
9. 1987 Wisconsin Fish Consumption Advisory for Green Bay and the Lower Fox River	51
10. Number and Daily Capacity of Wisconsin Paper Mills, 1980	57
11. Total Water Quality Control Grants and Associated Expenditures: Wisconsin, Green Bay and the Lower Fox River, 1973-1987	62
12. Fisheries Rehabilitation Objectives, Lower Green Bay and Fox River Area of Concern	67
13. Water Quality and Toxic Substances Objectives, Lower Green Bay and Fox River Area of Concern	70
14. Wildlife and Habitat Management Objectives, Lower Green Bay and Fox River	71
15. Description of the Key Actions Considered in the Lower Green Bay Remedial Action Plan	73
16. New Capital and Discrete Project Costs Associated with Green Bay Remedial Action Plan by Priority Level (\$1,000)	74
17. New Annual Operation, Maintenance and Program Management Costs Associated With the Green Bay Remedial Action Plan (\$1,000)	75
18. Detailed Distribution of New Costs Associate with The Remedial Action Plan for Lower Green Bay	76

19.	Alternative Phosphorus Effluent Standards for Meeting Desired Phosphorus Objectives	82
20.	Non-Point Source Phosphorus Control Alternatives	83
21.	Characteristics of Three Regions of the Bay of Quinte	91
22.	Drainage Areas, River Flows, and Land Use Characteristics, Bay of Quinte	92
23.	Seasonal Sportfishing Harvest by Fish Species, Bay of Quinte 1981-1986.	110
24.	Total Yearly Walleye Sport Fishing Effort, Bay of Quinte 1981-1986.	110
25.	Catch per Unit Effort, Bay of Quinte Sport Fishery, 1981-1986 by Species	111
26.	Mean May-October Values of Various Phosphorus Related Parameters, by Bay Location, 1972-1985.	113
27.	Values of Dissolved Oxygen, Indian Point 1945-1973	119
28.	Absolute and Net Inputs of Phosphorus and Nitrogen Loadings (1000 lb/yr) Into the Bay of Quinte, by Source, 1968.	120
29.	Mean Point Source Loadings of BOD, TSS and Phosphorus by Source, 1981-1986, Bay of Quinte (kg/yr)	122
30.	Summary of Basin Characteristics Associated with the Bay of Quinte, 1986	128
31.	Phosphorus and Suspend Solid Loadings from Non-Point Sources by Watershed Basin	129
32.	Delivery of Suspended Solids and Phosphorus by Season, Basin and Bay Location (MT/YR)	131
33.	Mean Values of Heavy Metals (mg/l) and PCBs (lg/g) in Bay of Quinte Sediments-Variou Locations, 1982	142
34.	Key Concerns Affecting the Remdial Action Plan of the Bay of Quinte	144
35.	Current Water Quality Variable Values (May-October), Upper Bay of Quinte and Interim Objectives	146
36.	Costs of Achieving a 3 MG/L Phosphorus Point Source Summer Effluent Limit (1987 \$CDN)	147
37.	Costs of Implementing BAT at Industrial Point Source Dischargers to the Bay of Quinte (1987 \$CDN)	148

38.	Characteristics of Watersheds Considered for the On-Farm Economic Analysis of Reduced Soil Erosion	149
39.	Delivery of Sediment (Tonnes) and Phosphorus (KG) to the Bay of Qunite Under Alternative Rotations, Tillage Practices, and Season, by Subwatershed Region	151
40.	Net On-Farm Economic Effects of Adoption of Conservation Tillage (1987 \$CDN)	154

List of Figures

<u>Figure</u>	<u>Page</u>
1. Map of the Green Bay Area of Concern	3
2. Map of the Bay of Quinte Area of Concern	6
3. Total and Alewife Harvests in Southern Green Bay	10
4. Commercial Yellow Perch Harvests, Southern Green Bay, 1936-1985 . .	12
5. Percent and Absolute Change in Commercial Yellow Perch Harvests . .	14
7. Percent of Total Commercial Catch in Southern Green Bay From Native Species	18
8. Composition of Commercial Catch of Native Species: Southern Green Bay	20
9. Composition of Commercial Catch of Yellow Perch, Alewife, and Carp by Weight, Southern Green Bay	22
10. Distribution of the Value of Commercial Harvest by Major Species Categories, Southern Green Bay	30
11. Total Point Source Effluent Loadings to the Lower Fox River, 1956-1986	32
12. Percent of Point Source Effluent From the Pulp and Paper Industry, Lower Fox River	33
13. Dissolved Oxygen Levels at the Proctor and Gamble Intake, 1971-1984	35
14. Point Source BOD and Suspended Solid Loadings to the Lower Fox River	37
15. Percent Point Source BOD and TSS from Pulp and Paper Industry, Lower Fox River	39
16. Concentration of BOD and TSS in Pulp and Paper Effluent-Lower Fox River	40
17. Phosphorus Loadings by Point Sources into the Lower Fox River . . .	46
18. Phosphorus Point Source Loadings from Municipal Waste Treatment Plants, Lower Fox River	47
19. Phosphorus Concentration in Point Source Effluent, Lower Fox River	48
20. PCB Concentration and Distance from the Mouth of the Fox River . .	53

21.	PCB loadings by the Pulp and Paper Industry, Lower Fox River . . .	54
22.	Pulp and Paper Mill Point Source Loadings of Toxic Materials, Lower Fox River, 1973-1986	55
23.	Water Pollution Control Capital Expenditures by the Fox River Pulp and Paper Industry	59
24.	Operating and Maintenance Expenditures by Waste Water Plants, Lower Fox River	63
25.	Total Commercial Harvest, Bay of Quinte	94
26.	Major Commercial Species Harvested, Bay of Quinte	95
27.	Commercial Harvest of Northern Pike and Walleye, Bay of Quinte . .	96
28.	Commercial Harvest of Northern Pike and Walleye, Bay of Quinte . .	98
29.	Yellow Perch and White Perch as a Percent of Bay of Quinte Harvest	100
30.	Commercial Gillnet Effort- White Perch, Bay of Quinte	101
31.	Distribution of Commercial Effort by Net Size- White Perch, Bay of Quinte	102
32.	Catch Per Unit Gillnet Effort by Net Size- White Perch, Bay of Quinte	104
33.	Total Value of Commercial Harvests, Lake Ontario and the Bay of Quinte	105
34.	Current and Deflated Value of Commercial Harvests, Bay of Quinte .	107
35.	Distribution of Total Value of Harvest by Fish Species, Bay of Quinte	108
36.	May to October Phosphorus Concentration by Location, Bay of Quinte	115
37.	Mean Chlorophyll <u>a</u> Concentration, Bay of Quinte	116
38.	Mean Secchi Disk Depthers, Bay of Quinte	117
39.	Point Source Phosphorus Loadings, Bay of Quinte	123
40.	Annual River and Total Phosphorus Loadings, Bay of Quinte	124
41.	Summer Loadings of Phosphorus, Bay of Quinte	125
42.	Drainage Basin Locations, Bay of Quinte	127
43.	Total Phosphorus Loadings, Annual and Summer-Bay of Quinte	132

44.	Corrected and Uncorrected Phosphorus Loadings-Bay of Quinte	133
45.	Phosphorus Budgets, Bay of Quinte 1972-1981	134
46.	Total Nitrogen Concentration by Location, Bay of Quinte	137
47.	Total and River Nitrogen Loadings, Bay of Quinte	138
48.	Percent of Total Nitrogen Loadings from the Bay of Quinte Watershed Sources	139
49.	Nitrogen Budgets, Bay of Quinte 1972-1981	141

I. Introduction

In an early Great Lake Fishery Commission report, Francis et al. (1979) provided estimates of the costs of Great Lakes rehabilitation including point and non-point pollution control costs and the costs of fisheries management. That study focused on the Great Lakes as a whole. In the present study we will generate updated estimates by (i) incorporating new information where possible and (2) generating estimates for two specific Great Lake ecosystems: Green Bay and the Bay of Quinte. These two ecosystems have been identified as areas of concern (AOC) in the Great Lakes by the International Joint Commission (Great Lakes Water Quality Board, 1975) and are the subject of efforts aimed at developing Remedial Action Plans (RAP's).

The 1978 Water Quality Agreement and the U.S. Environmental Protection Agency advocate the use of an ecosystem approach to the management of the Great Lakes and to the rehabilitation of the areas of concern. In this report we will be examining the costs of rehabilitation using such an approach. That is, we will examine not only the costs directly associated with fisheries management, but also the costs of improving water quality, controlling toxic substances, and maintaining wildlife habitat. A broader approach is justified because the benefits of such activities are clearly not associated solely to improved fishery resources, other benefits include improvement in the quality of other types of water-based recreation, improved wildlife habitat, reduced health costs, and lower costs for obtaining clean drinking water.

This report will be divided into two major sections: one concerned with the southern Green Bay ecosystem and the other, the Bay of Quinte. Each

major section will follow a similar pattern. First, we will present an historical overview of changes in the commercial and sport fisheries in each region. This will be followed by a review of water quality characteristics in terms of levels of dissolved oxygen, phosphorus concentration, effluent loadings, and the loading of toxic and other substances into these two regions. Next, an examination of expenditures undertaken by industry and municipalities to maintain water quality will be presented where available.

Since a preliminary remedial action plan (RAP) for Green Bay was released in February, 1988, we will provide an overview of the objectives set out in that document. Emphasis will be placed on those objectives directly related to fishery management. We will also provide a brief discussion of other objectives given the ecosystem approach adopted in this report. For the Bay of Quinte, we will discuss the preliminary goals and objectives presented in a recent progress report of the remedial action plan for this region.

The last part of each section will provide an overview of the costs of rehabilitating each Bay's ecosystem. Again, these estimates will be obtained from a review of the literature associated with each area.

1.1 Description of Green Bay and The Bay of Quinte

1.1.1 Characteristics of Green Bay

Green Bay drains approximately 40,000 km² which represents one-third of the total Lake Michigan drainage basin (Figure 1). The Bay itself represents less than 8 percent of the surface area of Lake Michigan. It is a shallow estuary-like bay with a length of 193 km and a mean width of 37 km. The depth gradient ranges from 2-3 meters at the southern end to 29 meters in the northern portions of the Bay. Only in a few places near the

Figure 1: Map of the Green Bay Area of Concern

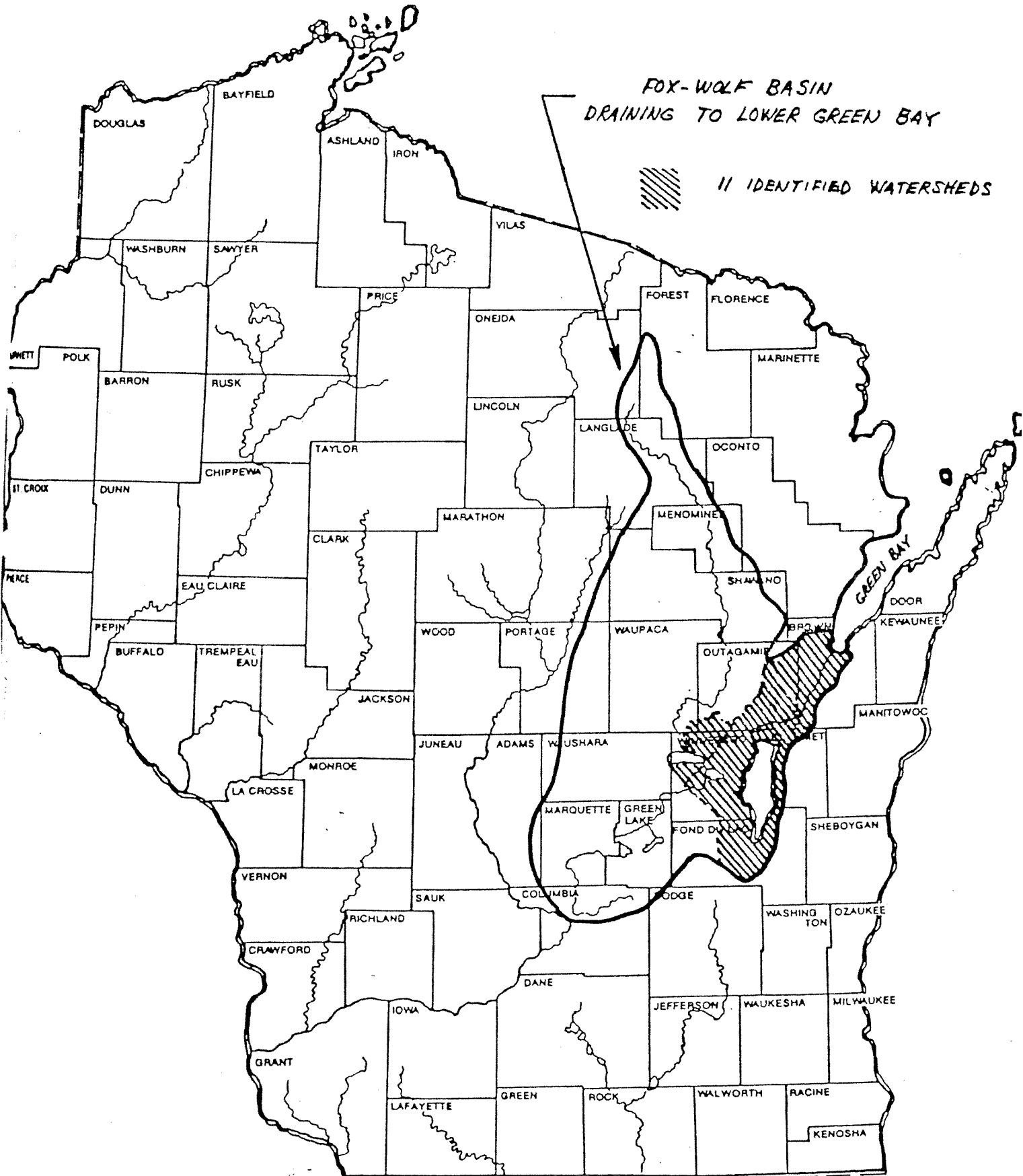

middle part of the Bay do depths exceed 60 meters. Water quality conditions range from oligotrophic high quality conditions in the northern end of the Bay to hypereutrophic low quality conditions in the lower Bay.

Bertrand et al.(1976) provides an historical overview of the physical, chemical, biological and socioeconomic characteristics of the Green Bay region. Harris et al.(1987) update this information and provide an evolutionary perspective to recent water quality improvement policies undertaken in the region.

The major rivers of Wisconsin which discharge into Green Bay are the Fox, Oconto, Peshtigo, and the Menominee. The Fox River accounts for more than 40 percent of the flow into the Bay. As will be discussed later, the Fox River accounts for most of the PCBs discharged into the Bay as well as phosphorus, BOD and suspended solids. The average annual flow of the Lower Fox River is $116 \text{ m}^3/\text{sec}$ with maximum and minimum flows of 340 and $55 \text{ m}^3/\text{sec}$, respectively (Harris et al., 1987 p.55). This sizeable flow gave impetus to the development of a pulp and paper industry to the point that the Lower Fox River supports the highest concentration of paper mills in the world. Historically, this concentration of pulp and paper mills has resulted in a level of effluent loadings with a population equivalent of 1.3 million people (Epstein et al., 1974 p.2).

In addition to the large concentration of industry on the Lower Fox River watershed, over 400,000 people live in this area. Major cities in the watershed include Green Bay, Appleton, Depere, Neenah and Menasha. Currently, 13 pulp and paper mills discharge treated waste water directly to the Fox River. In addition, there are 7 major municipal wastewater treatment facilities.

1.1.2 Characteristics of the Bay of Quinte

The Bay of Quinte is a Z-shaped bay 64 km long with a total area of 254 km² (Figure 2). The Bay becomes wider and deeper from the upper to the lower end. The major population centers are in the northern part of the bay. The Bay's watershed covers an area approximately 18,200 km² with major river inputs in the upper part of the Bay from the Trent, Moira, Salmon and Napanee rivers.

The Bay of Quinte has experienced significant cultural eutrophication since the mid-1940's. This has been the result of increased point source loadings along with low water flows through the bay (Johnson, 1986). The upper region of the Bay, because of its shallowness, has always been more eutrophic than the deeper lower region of the Bay. Over half of the population in cities and towns on the Bay are located in the municipalities of Trenton, Belleville, Desoronto, Napanee and Picton. In addition to these municipalities, a Canadian Department of National Defense base at Trenton discharge treated wastewater to the Bay. Because of the location of the cities in the upper portion of the Bay, point source loadings of phosphorus occur mainly in this region. Over 80 percent of the point source inputs of phosphorus has historically originated from the cities of Belleville and Trenton (Johnson, 1986 p.248).

The Bay is used as a source of water supply for Belleville and Desoronto. Because of the abundance of blue-green algae resulting from the eutrophic conditions, the ability to provide potable water became more difficult and expensive with worsening conditions. In addition, many recreational activities have been negatively affected by reduced water quality.

Along with an increase in eutrophic conditions and associated increase in

Figure 2: Map of the Bay of Quinte Area of Concern

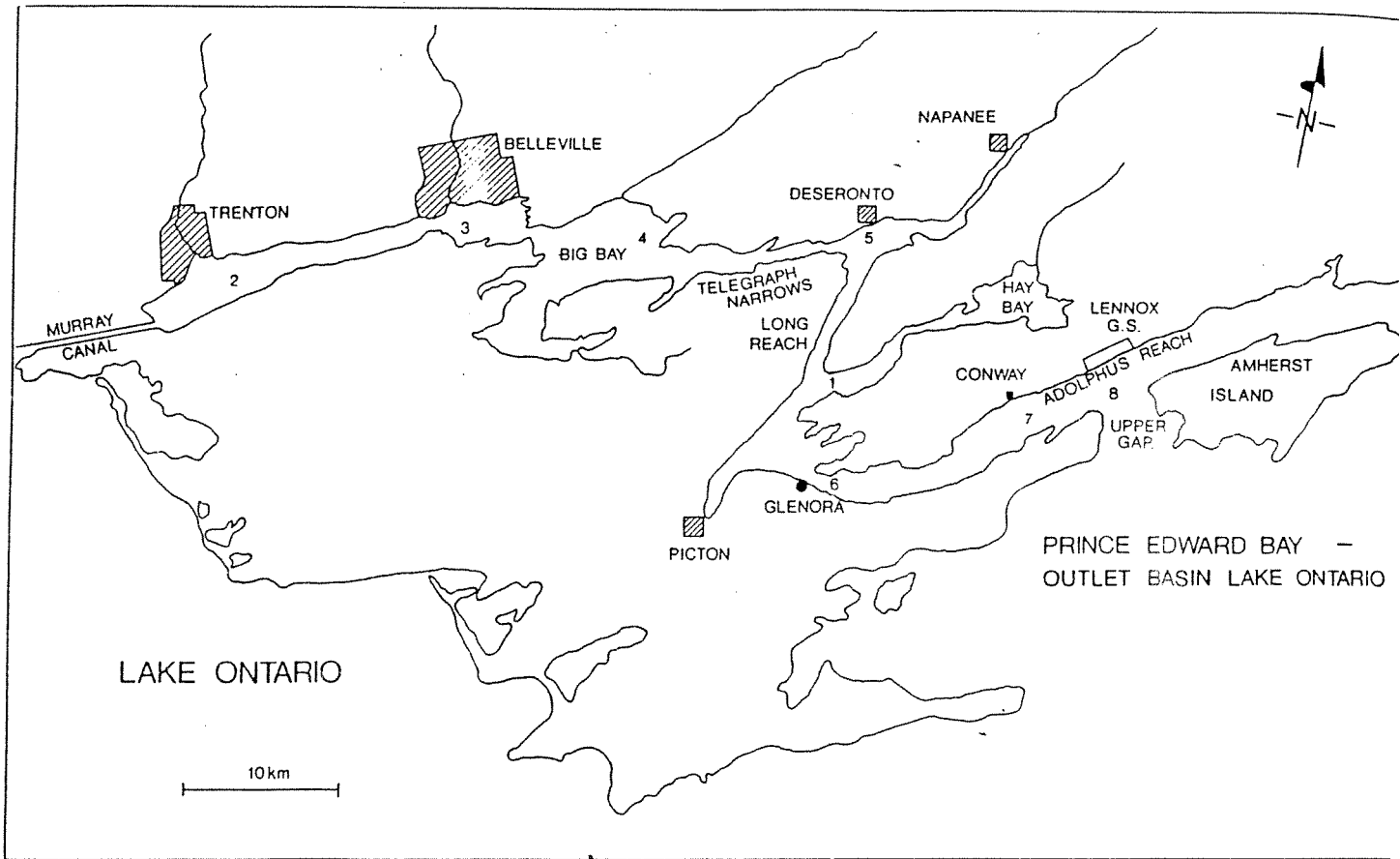

Source: Minns and Hurley (1986)

abundance of blue-green algae, there has been a dramatic change in the fish population present in the Bay. Hurley and Christie (1977) note that the decline in piscivore population observed in the Bay is directly due to cultural eutrophication that occurred prior to the late 1970's. With a decreased piscivore population, there has been an increase in the presence of exotic species such as white perch and alewives.

Because of the unique characteristics associated with this area, scientists from Federal and provincial government agencies and several universities came together in a collaborative effort over the 1972-1985 period to examine the impacts of reduced phosphorus loadings initiated in 1978. This activity came to be known as "Project Quinte". Out of this project, a special issue of the Canadian Journal of Fisheries and Aquatic Sciences was published in 1986 (Minns et al., 1986). An ecosystem approach was applied in this collaborative effort. As noted in Johnson and Hurley (1986), the major question that was investigated was "...would P reduction to prescribed levels increase production of economically important fish stocks, and improve water quality both for municipal supplies and for various recreational activities in the Bay of Quinte in a reasonable length of time" (p.4). The Bay of Quinte was well suited to the ecosystem approach because (i) it is representative of other areas of the lower Great Lakes, (ii) it is small enough to encourage multi-year studies while requiring relatively small budgets, and (iii) the Bay of Quinte has been the subject of considerable research since the 1950's. As such, substantial past water quality data is available.

II. Historical Overview of Water Quality and the Fisheries of Southern Green Bay and the Lower Fox River

This section of the report will review the status of water quality and fisheries in southern Green Bay. Water quality will be examined by an analysis of concentration levels and point and non-point source loadings into the lower Fox River, the major tributary to Green Bay. The magnitude of point source loadings of various materials was obtained from unpublished data collected by the Wisconsin Department of Natural Resources (WDNR), Bureau of Water Quality Management. Loadings of phosphorous from non-point sources are estimated from data presented in the Technical Advisory Committee's report to the Green Bay RAP. Commercial fishery data was obtained from published data supplied by the U.S. Fish and Wildlife Service, Great Lakes Fishery Commission (Baldwin et al., 1979) and the Great Lakes Fishery Laboratory in Ann Arbor, Michigan. Sport fishing data was obtained from unpublished creel surveys conducted by the WDNR.

As noted in Harris et al. (1987), the Wolf-Fox River system contributes the largest volume of water to Green Bay and most of the suspended and dissolved pollutants entering the bay. In addition, 50-80 percent of the water, by volume, within 5-7 km of the river's mouth consists of Fox River water. The share of water originating in the Fox River decreases rapidly with values greater than 25 percent seldom observed beyond 25 km (p.9). Given this characteristic, we will be limiting our analysis of the fishery of Green Bay to the changes that have occurred in Southern Green Bay.¹

2.1 Overview of Commercial and Sport Fisheries in Southern Green Bay

¹In the examination of changes in the commercial and sport fisheries, Southern Green Bay was defined to encompass fisheries management district WM-1.

There has been a highly productive commercial fishery in Green Bay for more than a century. Over the last thirty years, the composition of this fishery has changed dramatically not only in terms of the quantity and type of native fish species that are harvested but also with respect to the dramatic increase in the harvesting of exotic species (University of Wisconsin Sea Grant, 1986). In the following sections we briefly review the trends in commercial production. When reviewing this information it should be remembered that changes in commercial catch levels may reflect factors other than the composition and size of fish populations, such as changes in input and output prices which have an effect on the level of fishing effort.

As will be discussed later, the total commercial fishing harvest in Southern Green Bay has been greatly influenced by the level of alewife (*Alosa pseudoharengus*) production. Figure 3 shows that prior to 1965, the harvests in Southern Green Bay were relatively constant at 4-5 million pounds. With the increase in alewife harvests during the mid- 1960's, total harvests increased more than 5 times with a maximum production observed in 1973 of 26 million pounds. This level has decreased as quickly as it had increased with production back to a pre-1965 level by the late 1970's.

Currently, in Green Bay there are commercial harvest quotas only on the yellow perch (*Perca Flavescens*) fishery. Other commercial species are not regulated by harvest quotas and can be harvested by all licensed commercial fishers. In addition to alewives, yellow perch and lake whitefish (*Coregonus clupeaformis*), other fish species that are commercially harvested include suckers (*Catostomus commersoni*), sheepshead (*Aplodinotus grunniens*), burbot (*Lota lota*), white bass (*Roccus chrysops*), round

FIGURE 3
TOTAL AND ALEWIFE HARVESTS
IN SOUTHERN GREEN BAY

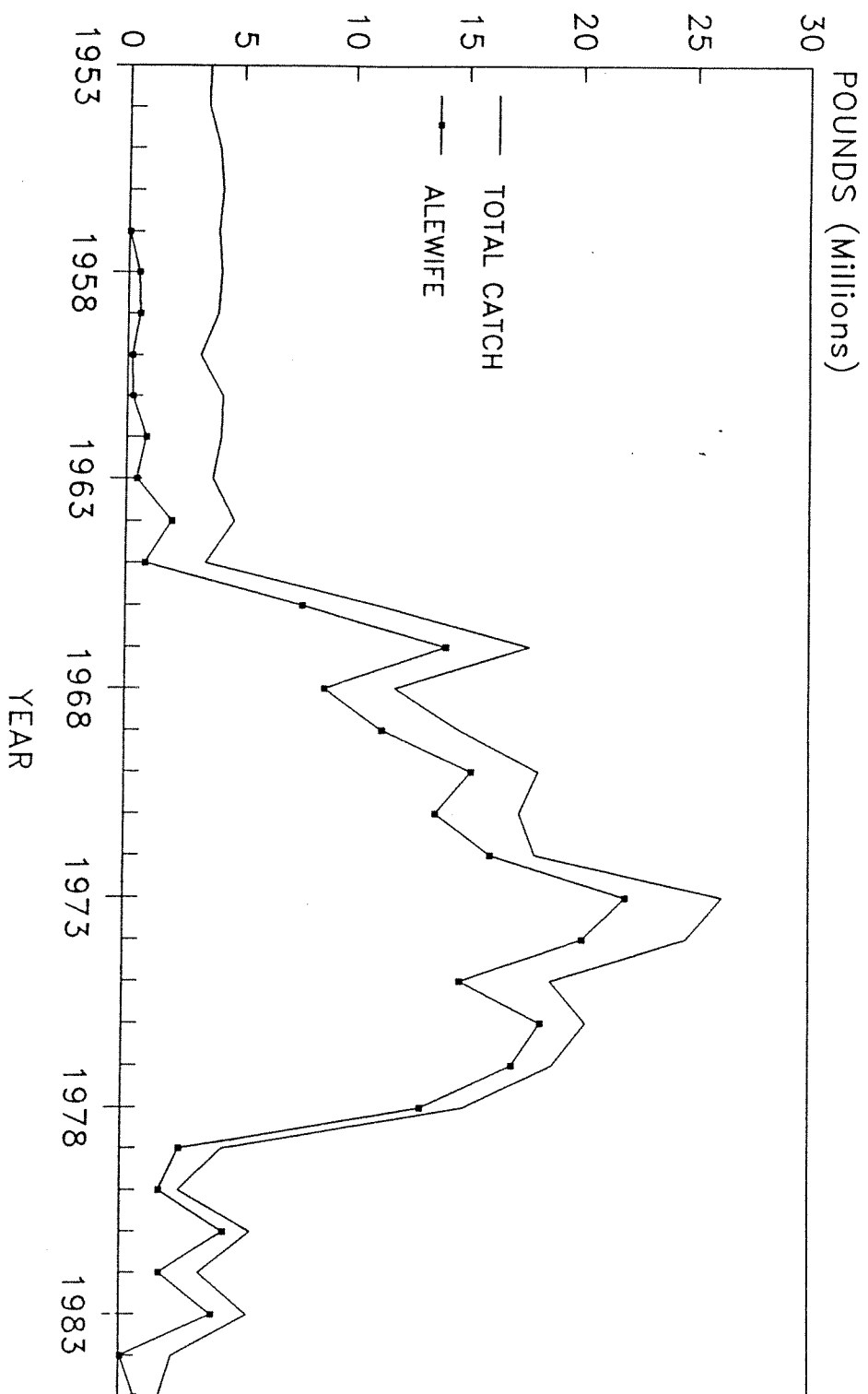

Source: Baldwin et al. (1979) and unpublished U.S. Fish and Wildlife Service data

whitefish (*Prosopium cylindraceum*), northern pike (*Exos lucius*), and catfish (*Ictalurus punctatus*). All except whitefish are usually harvested incidentally to the harvesting of other major species. Commercial fishers are currently barred from taking several species including walleyes (*Stizostedion vitreum vitreum*) and the various trout and salmon species.

2.1.1 Recent Changes in the Southern Green Bay Yellow Perch Fishery

The yellow perch fishery of Southern Green Bay has been extremely variable. The maximum level of commercial yellow perch production from Southern Green Bay occurred in 1943 when 2.4 million pounds were harvested. The lowest level of commercial production occurred in 1983 when less than 150,000 pounds were harvested. Since then, a commercial fishing quota has been in effect and has been at a level of 350,000 pounds in recent years. Figure 4 displays the time series of yellow perch production in Southern Green Bay over the 1936 to 1985 period. Over the 50 year period, the average level of production was 839,000 pounds with a coefficient of variation of 1.66.

Between 1936-1965, the commercial yellow perch harvest averaged 1.1 million pounds compared to slightly more than 400,000 pounds between 1965-1983. The dramatic drop in production since 1965 has been the focus of considerable research. Milliman (1985) reviews some of the hypothesized reasons for the decline. As noted in Larue and Mclain (1973), the decline in yellow perch abundance across Lake Michigan followed a progression similar to the increase in alewife abundance. Besides competing for habitat and food, the alewives were hypothesized to affect perch by feeding on their eggs (University of Wisconsin Sea Grant, 1986). A second explanation for the decline in fish numbers is the reduced oxygen levels in Southern Green

FIGURE 4
COMMERCIAL YELLOW PERCH HARVESTS
SOUTHERN GREEN BAY, 1936-1985

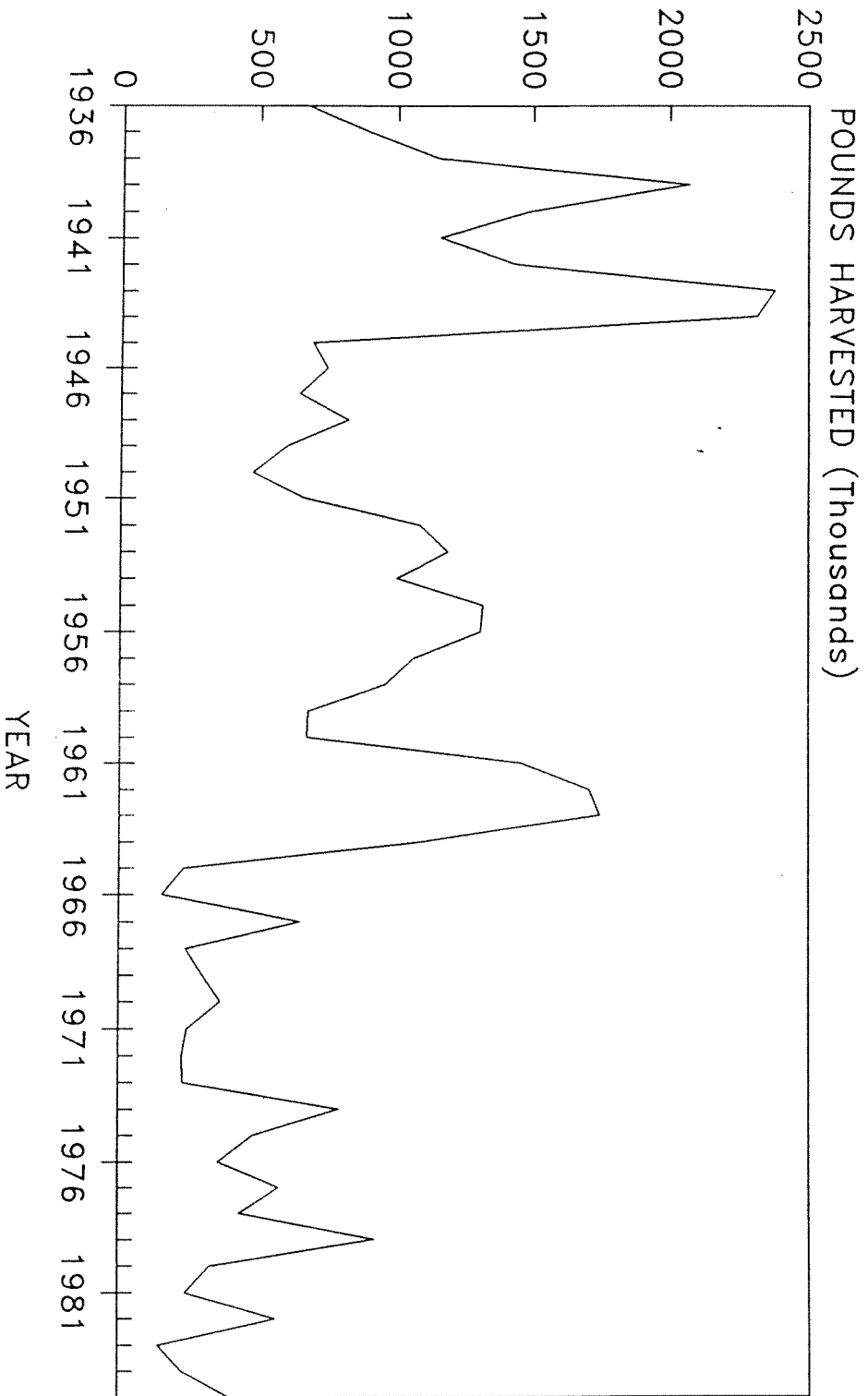

Source: Baldwin et al. (1979) and unpublished U.S. Fish and Wildlife Service data

Bay. As noted by Kraft(1982) to a greater extent than catfish or carp (Cyprinus Carpio), yellow perch are sensitive to low dissolved oxygen levels which had worsened in Green Bay during the 1950's and 1960's. A third reason for the decline in yellow perch numbers may have been the increased abundance of another exotic species, the carp. It has been hypothesized that the carp uproot the aquatic vegetation upon which the yellow perch rely upon for spawning and thus reducing spawning success. A fourth reason for the reduction in yellow perch may have been commercial over-exploitation. The filling in of the marshes which had previously been used as spawning habitat has also been put forward as another reason for recent declines (Kraft, 1982).

In his analysis of the Green Bay fishery, Griffen (1979) noted that fluctuations in the total commercial catch of yellow perch became more severe after the early 1960's. This he took as indicative of a fishery experiencing overexploitation. Updating his analysis, Figure 5 shows the percentage change in harvest of yellow perch over the 1937-1985 period.² Prior to 1965, the mean absolute percentage change was 30.0 percent compared to 71.3 percent since. Examining the magnitude of change in the harvest we see that there was little difference between the variation before the early 1960's vs. later (Figure 5). Before 1965, the mean absolute change in annual harvest was 338,000 pounds compared to 269,000 pounds after 1965. These results show that the problems that existed in the fishery in its early period of exploitation still exists.

In addition to his analysis of the change in catch, Griffen (1979) analyzed the change in the catch per unit effort (CPE) and total effective

²The percentage change is calculated as: $(\text{Year 2} - \text{Year 1})/\text{Year 1}$

FIGURE 5
PERCENT AND ABSOLUTE CHANGE IN
COMMERCIAL YELLOW PERCH HARVESTS

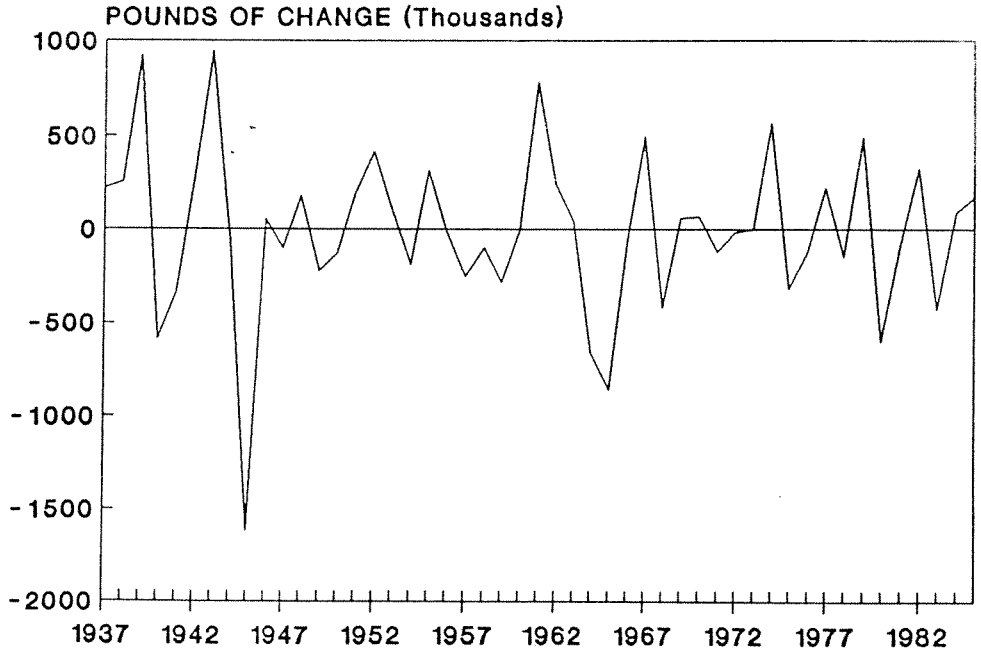
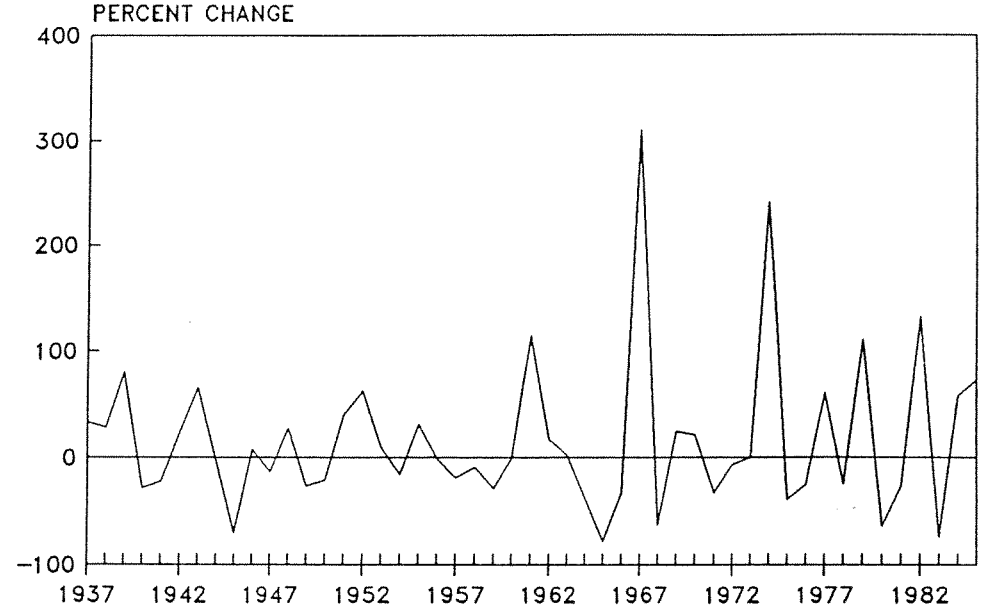

Source: Baldwin et al. (1979) and unpublished U.S. Fish and Wildlife Service data

effort. Not surprisingly, he found a correlation between CPE and total catch. In general he notes:

- i. CPE's have increased in the late 1970's after recovering from the dramatic decreases in the early 1960's;
- ii. Given the downward trend in total catch, there has been an associated downward trend in total effort; and
- iii. While fluctuations are generally characteristic of the Green Bay yellow perch fishery, the post-1960's period has been marked by more dramatic annual fluctuations in total catch [on a percentage basis] as well as CPE and effective effort which implies that in any year, total catch, effective effort and CPE may vary considerably (Griffen, 1979).

The importance of yellow perch to the Southern Green Bay fishery can be seen from Figure 6. In this figure, we see that Southern Green Bay usually produces a large proportion of Lake Michigan yellow perch harvest accounting for an average of over 39 percent for the 1953-1985 period. The largest share occurred in 1977 with over 80 percent of the Lake Michigan catch occurring in Southern Green Bay and the lowest occurring in 1984 with 15 percent. Historically well over 95 percent of the yellow perch caught in Green Bay has been caught in the southern district.

By 1978 the WDNR was concerned with the status of the yellow perch fishery in Green Bay. Several goals were established which included: (i) more and larger perch, (ii) a balanced, stable perch population, and (iii) a more equitable division of the perch harvest between sports and commercial fishers. The goal for commercial fishers to be achieved by 1991 was an annual harvest of 600,000 pounds and CPE of 39.1 pounds and 26.1 pounds for gill nets and drop nets, respectively. In terms of the sport fishery, harvest goals of between 240,000 to 475,000 pounds by 1991 were established. In order to achieve these goals, the WDNR proposed that the total commercial harvest be restricted to 200,000 pounds for the 1983-1984

FIGURE 6
PERCENT OF LAKE MICHIGAN YELLOW PERCH
HARVESTED FROM SOUTHERN GREEN BAY

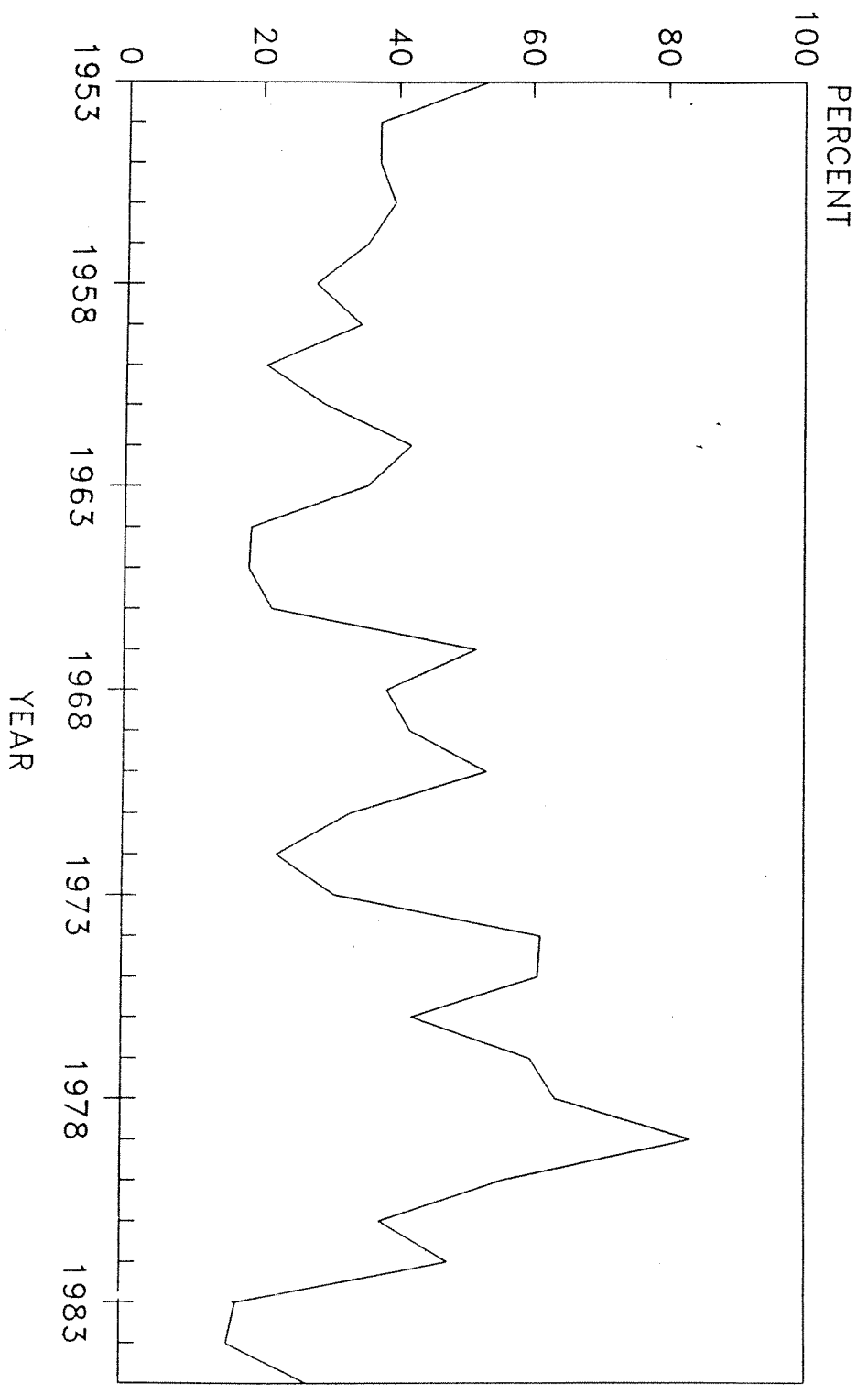

Source: Baldwin et al. (1979) and unpublished U.S. Fish and Wildlife Service data

licensing year and the closed season be extended from May 20 to July 1. A sport harvest daily bag limit of 25 fish was proposed (Milliman, 1985 p.124-125).

Ready (1988) conducted a cost-benefit analysis of several variations of the current WDNR rehabilitation plan for Green Bay and found that:

- (i). There were positive net benefits under the current rehabilitation plan;
- (ii). Commercial fishers are worse off with rehabilitation than under the no rehabilitation scenario. The gains to sport fishers outweigh the losses to commercial fishers; and
- (iii). Further restrictions on commercial harvest could generate even higher net benefits than under the current rehabilitation program.

The final conclusion reached by the author is that given the desire of the WDNR not to deviate from the 50/50 split of the yellow perch harvest between commercial and sport fishers, the current policy is quite reasonable.³

2.1.2 Changes in the Commercial Catch of Other Native Species

Of the native species present in Southern Green Bay, the yellow perch fishery has traditionally been the most important.⁴ The relative importance of commercially harvested native species is shown in Figure 7 over the 1953 to 1985 period. With the dramatic increase in the alewife population in the early 1960's there was a dramatic drop in the importance of native species with a decline from 50 percent of the total catch in pounds prior to 1964 to less than 10 percent between 1965 and 1978. Since 1978, there has been an

³For a more detailed discussion of the current rehabilitation plan for Green Bay refer to Ready (1988).

⁴Besides yellow perch, other fish species classified as native were bullheads, burbot, catfish, chubs, northern pike, sheepshead, suckers, and whitefish. Exotic species that have been commercially harvested include alewives, carp, and smelt.

FIGURE 7
PERCENT OF TOTAL COMMERCIAL CATCH IN
SOUTHERN GREEN BAY FROM NATIVE SPECIES

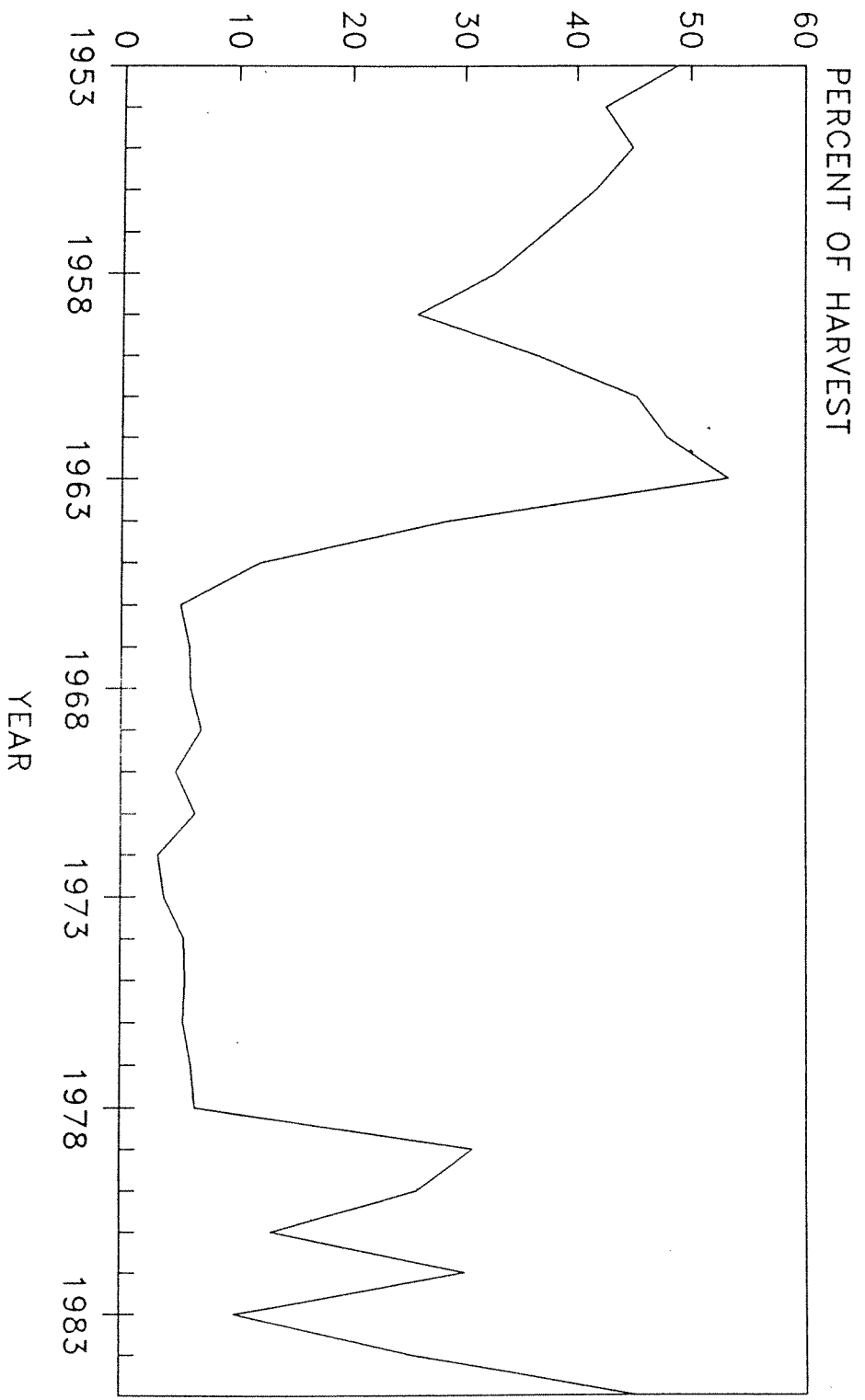

Source: Baldwin et al. (1979) and unpublished U.S. Fish and Wildlife Service data

increase in the importance of native species averaging 30 percent of the total catch.

Not only has the importance of native species for commercial harvests changed over the last thirty years, the composition of the native species grouping has also varied. In Figure 8, we see that with the reduction in yellow perch harvests after the early 1960's, there was a relative increase in the harvest of sucker, burbot and whitefish. The level of sucker harvest in Southern Green Bay has been quite variable and reached a maximum production level in 1971 with 750,000 pounds. Since 1973, harvests have been less than 350,000 pounds. Prior to 1968, whitefish harvests averaged less than 20,000 pounds. A maximum level of production was observed in 1976 with slightly less than 250,000 pounds and has experienced a stable production level since then at approximately 140,000 pounds.

2.1.3 Role of Exotic Species for Commercial Production in Southern Green Bay

As with other Great Lakes ecosystems, the rise in the abundance of exotic fish species has dramatically changed the characteristics of the fish community present in Green Bay. The major exotic species that have significantly affect the Southern Green Bay fishery are the sea lamprey (*Petromyzon marinus*), alewife, smelt, and carp. The first sea lamprey was observed in Lake Michigan in 1934. With no natural predators, the lamprey population quickly increased and severely affected Great Lakes fish populations, particularly lake trout and whitefish. The commercial catch of lake trout in Wisconsin waters of Lake Michigan decreased from 2.8 million pounds in 1940 to 25,000 pounds ten years later. As noted in the 1986 Biennial Wisconsin Sea Grant report, the burbot and whitefish populations in the upper Great Lakes were similarly devastated by the sea lamprey. In

FIGURE 8
 COMPOSITION OF COMMERCIAL CATCH OF
 NATIVE FISH SPECIES--SOUTHERN GREEN BAY

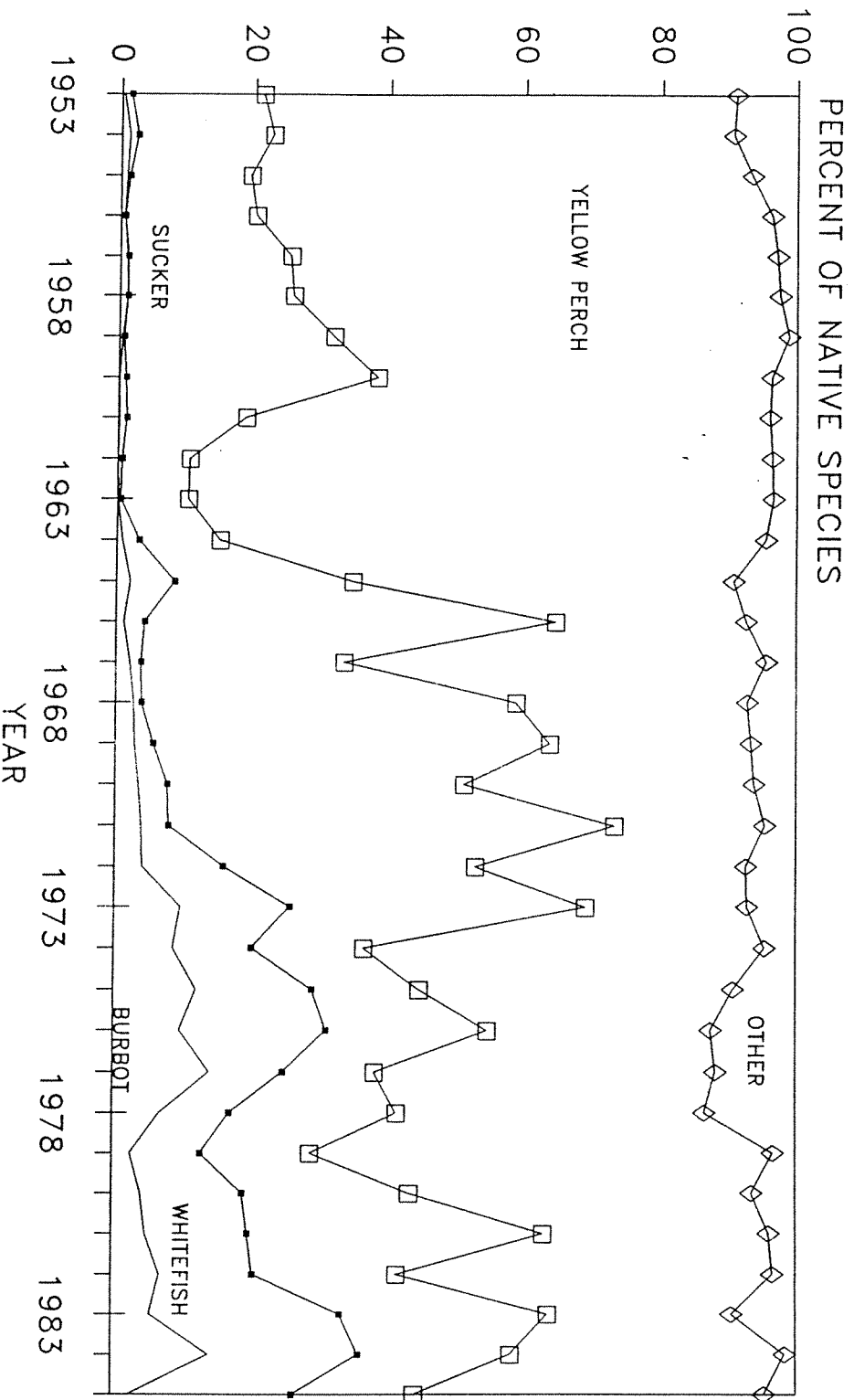

Source: Baldwin et al. (1979) and unpublished U.S. Fish and Wildlife Service data

combination with the effects of overfishing, the authors note that the sea lamprey wiped out many of the large ciscoe species in the three upper Great Lakes (University of Wisconsin Sea Grant, 1986, p.9).

As noted by Kraft (1982), because few predators remained in the lakes after the sea lamprey invasion, the alewife population increased dramatically during the 1940's-1950's. Because of the decline in the abundance of other valuable fish species in Southern Green Bay, commercial fishermen turned to the alewife which are used in fish meal, fertilizer, and pet food. Starting from zero in 1956, by 1964, 40 percent of the commercial harvest in Southern Green Bay was from alewives (Figure 3). Between 1967 and 1983, the average share increased to 80 percent.

Prior to mid 1970's carp represented the second most important fish species harvested in Southern Green Bay, by weight (Figure 9). Peak carp production occurred in 1973 when more than 3 million pounds were harvested. Before the closure of the fishery in 1984, the low level of production occurred in 1980 when less than 200,000 pounds were harvested. The commercial carp fishery was closed in 1984 due to excessive levels of PCBs found in commercially harvested carp.

2.1.4 Sport Fishing Activity in Southern Green Bay

Unlike the commercial fishery, historical data with respect to sport fishing activity in Southern Green Bay are not readily available. In recent years the WDNR has conducted an annual creel census of sport fishers in various regions of Wisconsin. In this census, information with respect to species caught, species harvested, hours fished and success rates were obtained. Using this data, overall sport harvest rates for Southern Green Bay have been estimated. Table 1, shows estimated sport fishing harvest in

FIGURE 9
COMPOSITION OF COMMERCIAL CATCH OF
YELLOW PERCH, ALEWIFE AND CARP

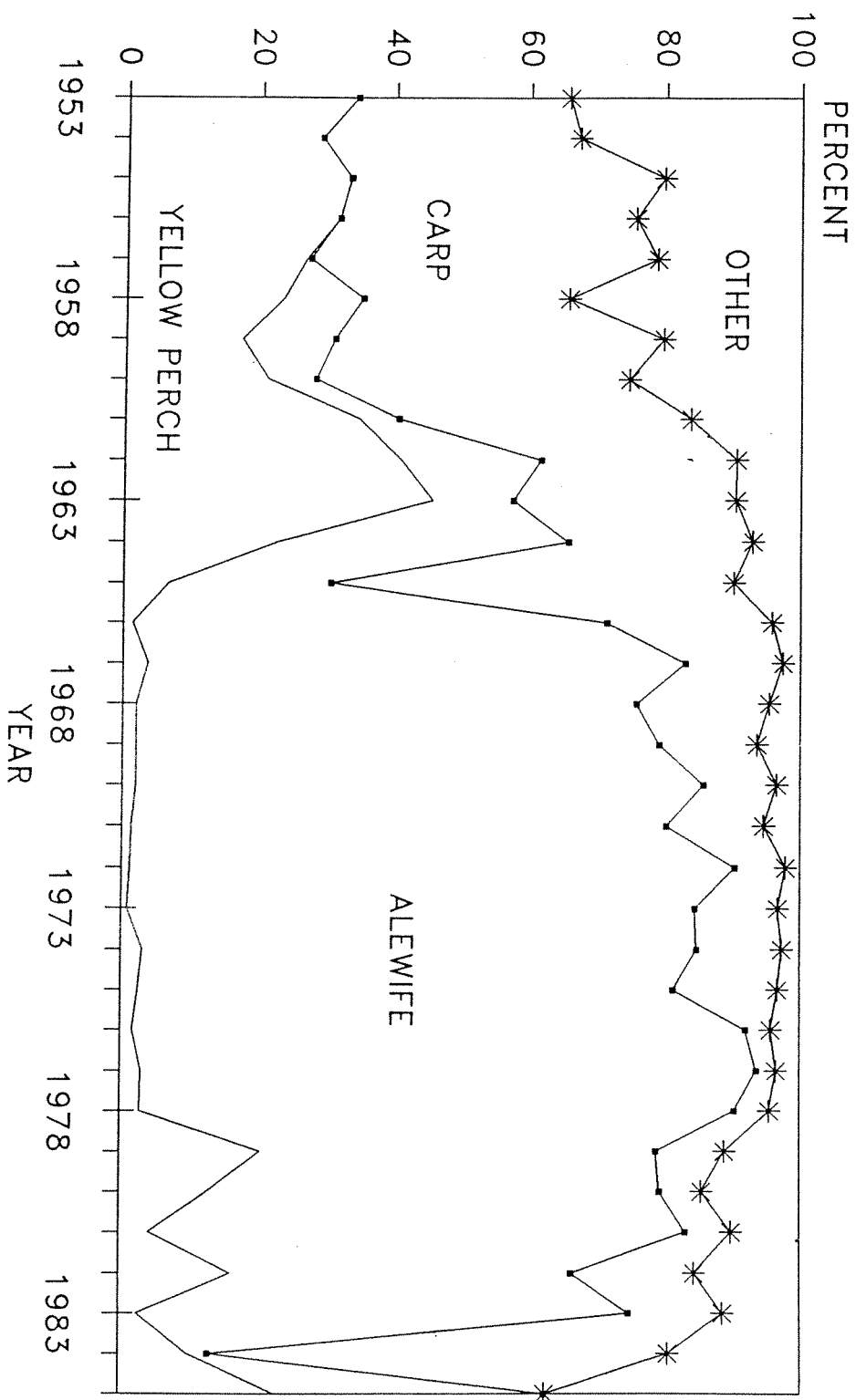

Source: Baldwin et al. (1979) and unpublished U.S. Fish and Wildlife Service data

Table 1. Sport Fishing Harvest, 1983-1985, Southern Green Bay
(number caught)

Species	1985	1984	1983
Northern Pike	3,472	2,891	689
Brown Trout	11,524	25,600	11,456
Yellow Perch	858,076	401,853	205,735
Walleye	39,890	7,487	626
Chinook Salmon	6,648	18,123	11,456

Source: Unpublished WDNR data

Southern Green Bay over the 1983-1985 period. From this table, we see that yellow perch is one of the more important species with more than 850,000 yellow perch caught in 1985. As noted in Milliman(1985), prior to 1983, the WDNR believed that sports fishers accounted for 15 percent of the total perch harvest in Green Bay. The 1985 creel census conducted by the WDNR showed that an overwhelming majority of fishermen contacted were fishing for yellow perch.

An indication of WDNR efforts at maintaining and rehabilitating the sport fishery in Green Bay can be obtained by examining the level of fish stocking over recent years.⁵ Table 2, shows the level of stocking by species over the 1978-1986 period for selected years. The data is partitioned according to whether the fish are stocked in the Southern portion of Green Bay vs. the northern portion of Wisconsin waters of Green Bay.⁶

⁵When reviewing the stocking numbers it should be noted that the salmon and trout stocking might not be considered to be rehabilitation by some since it is a put-grow-and-take program. Walleyes, on the other hand, are stocked to restore naturally reproducing populations.

⁶In Table 2, The southern portion of Green Bay was defined as grid numbers 802-804, 901,902, 1001, and the Lower Fox River.

Table 2. Level of Fish Stocking, Wisconsin Waters of Green Bay, 1978-1986

Year	Species	Age	Region of Green Bay		
			Southern	Other	Total
1986					
	Rainbow Trout	YLG	143,435	-----	143,435
	Brown Trout	YLG	34,800	92,100	126,900
		FGL	35,000	125,000	160,000
	Chinook	FGL	100,000	355,000	455,000
	Splake	YLG	-----	20,000	20,000
		FGL	22,500	72,500	95,000
	Steelhead	YLG	103,335	-----	103,335
		FGL	18,550	-----	18,550
1985					
	Rainbow Trout	YLG	20,000	5,000	25,000
		FGL	15,000	15,000	30,000
	Brown Trout	YLG	40,700	85,000	125,700
		FGL	65,300	100,000	165,300
	Brook Trout	YLG	5,000	-----	5,000
	Chinook	FGL	100,000	408,300	508,300
	Splake	YLG	-----	19,488	19,488
		FGL	35,000	-----	35,000
	Steelhead	YLG	25,177	-----	25,177
1984					
	Rainbow Trout	YLG	136,391	30,000	166,391
		FGL	39,092	19,717	58,809
	Brown Trout	YLG	-----	10,000	10,000
		FGL	-----	30,000	30,000
	Splake	YLG	20,000	-----	20,000
		FGL	-----	14,160	14,160
	Chinook	FGL	150,000	317,850	467,850
	Coho	FGL	150,000	-----	150,000
	Walleye*	FRY	4,000,000	-----	4,000,000
1980					
	Rainbow Trout	YLG	37,197	55,154	92,351
		FGL	45,000	16,000	61,000
	Brown Trout	YLG	21,200	54,000	75,200
		FGL	57,065	61,500	118,565
	Brook Trout	YLG	-----	15,000	15,000
	Chinook	FGL	220,000	414,200	634,200
	Walleye	FGL	354,235	89,000	443,235
		FRY*	10,000,000	-----	10,000,000

*Walleye fry were stocked in the Lower Fox River

Table 2., (continued)

Year	Species	Age	Region of Green Bay		
			Southern	Other	Total
1979					
	Rainbow Trout	YLG	11,700	65,820	77,520
		FGL	86,968	-----	86,968
	Brown Trout	YLG	39,400	40,700	80,100
		FGL	43,750	37,860	81,610
	Brook Trout	YLG	-----	13,620	13,620
	Chinook	FGL	100,000	195,000	295,000
	Walleye	FGL	127,463	-----	127,463
		FRY*	10,000,000	-----	10,000,000
1978					
	Rainbow Trout	YLG	7,890	19,280	27,170
		FGL	35,000	18,000	53,000
	Brown Trout	YLG	33,700	76,125	109,825
		FGL	181,700	87,560	269,260
	Brook Trout	YLG	-----	7,400	7,400
	Chinook	FGL	60,000	150,000	210,000
	Coho	YLG	-----	6,500	6,500
	Walleye	FGL	46,069	-----	46,069
		FRY*	8,000,000	-----	8,000,000

*Walleye Fry were stocked in the lower Fox River.

Given the level of stocking presented in Table 2, estimates of the cost of this activity for salmon and trout was obtained via the use of data presented in Bishop et al. (1989). In that report, hatchery and distribution costs of stocking various species and ages were estimated for the 1985 year class using hatchery specific data for those hatcheries that are used for the stocking of Lake Michigan salmonids. Table 3 presents these cost estimates.⁷ The cost categories included in this table are Feed, Labor, Distribution and "Other" costs. The costs covered in this study include current capital expenditures but depreciation is not included except in the case of the Distribution category where a depreciation mileage charge is included. Given the species specific cost estimates for the 1985 year class, total stocking cost were estimated for the stocking levels indicated by Table 2 by adjusting the cost estimates by changes in the consumer price index (CPI, Table 4). It was assumed that all yearlings (YLG) were stocked in the spring. Fingerlings (FGL) were assumed to be stocked in the fall of the year. From Table 4 we see that in terms of the entire Green Bay region, there has been a general increase in stocking expenditures from less than \$100,000 in 1978 to more than \$250,000 in 1986.

2.1.5 1986-1991 Lake Management Fish Management Plan and Green Bay

As noted earlier, in 1986 the WDNR released its management plan for Lake Michigan covering the 1986-1991 period. The general objectives, as stated in this plan were to:

⁷The large difference in costs estimates are due to the fact that certain hatcheries are used exclusively for certain species and age classes. Refer to Bishop et.al.(1988) for a detailed discussion of methods and data sources used.

Table 3. Cost of Stocking Lake Michigan Fish, 1985 Year Class

Species	Age	Cost/1000 Fish				Total
		Feed	Labor	Dist.	Other	
Brook Trout	FGL	14.01	108.44	38.12	92.93	253.51
	YLG	57.03	91.92	53.91	519.48	722.35
Brown Trout	FGL	23.65	76.41	27.05	192.58	319.68
	YLG	84.99	111.58	57.66	88.01	342.25
Rainbow Trout	YLG	38.24	72.73	45.31	84.66	240.94
Splake	FGL	9.77	37.45	5.66	82.52	135.41
Coho Salmon	YLG	23.86	146.06	23.07	315.12	508.11
Steelhead	YLG	17.86	22.57	11.65	673.28	724.71
Chinook	FGL	2.95	5.22	2.07	35.57	45.80

Source: Bishop et.al.(1988)

Table 4. Total Costs of Stocking Green Bay, 1978-1986 (in current dollars)

Year	Region of Green Bay		
	South	Other	Total
1978	50,613	48,714	99,326
1979	39,324	41,769	81,093
1980	43,503	65,877	109,380
1984	127,653	49,146	176,799
1985	74,753	90,052	164,805
1986	146,816	104,072	250,888

Source: Estimated from Bishop et.al.(1989) and unpublished WDNR data.

- (1) manage for a diverse, multi-species commercial fishery to allow an optimum sustained harvest;
- (2) manage for a diverse, multi-species sport fishery to allow an optimum sustained harvest and to provide a variety of angling opportunities; and
- (3) re-establishing self-sustaining lake trout populations to allow an optimum sustained sport and commercial harvest.

The term "optimum sustained harvest" was defined as the yield that would provide the people of Wisconsin with the greatest overall benefit in food production and recreational opportunities, taking into account the effects harvesting has on dependent or associated species (WDNR, 1986 p.3). In terms of specific commercial fishery objectives relating to the Green Bay fisheries, the plan was designed to: (i) manage the yellow perch population so as to allow by 1991 a sustained annual commercial harvest of 600,000 pounds, (ii) describe and characterize the northern pike population in Green Bay, and (iii) encourage the development of a fishery in Green Bay to harvest burbot, carp, suckers, and other species. In terms of the sport fishery of Green Bay, the plan had as its objectives: (i) manage Green Bay for an annual sport harvest of 1.2-1.9 million yellow perch that average 4-5 fish per pound, and (ii) manage the Green Bay walleye fishery to harvest an annual sport harvest of 50,000 fish from a population that has 10 age classes.

2.1.6 Conclusion

The above discussion has been primarily concerned with a review of the status of the commercial and sport fishery in Southern Green Bay. In order to more fully understand the importance of this region's fisheries, we can examine the value of commercial production. For the entire Green Bay, the value of the commercial harvest has averaged \$2.6 million annually between

1971-1985. The value of the southern region of Green Bay has historically accounted for 30-40 percent of the total bay's harvest.

The time profile of the contribution of various species to the total value of production (Figure 10) differs quite dramatically when compared to the time profile of species contribution to total physical production. The main reason for this difference being the higher prices observed for those species that are used for human consumption (e.g. whitefish and yellow perch) vs. the species that are used for animal feed (e.g. carp and alewives).

2.2 Water Quality Conditions in Southern Green Bay

There are four major rivers that drain into the lower two-thirds of Green Bay: Oconto, Menominee, Peshtigo, and the Fox River. Characteristics of these four rivers during the early 1970's are presented in Table 5. From this table, approximately 25 million cubic meters/day are discharged into Green Bay. The Fox River accounts for approximately 45 percent of the average flow. In the early 1970's, the Fox River accounted for more than 70 percent of the loadings of suspended solids and chlorides. Historically, over 90 percent of the point source loadings of PCBs entering Green Bay originated from the Fox River. Given the importance of the Fox River for Green Bay as a source of nutrients and other pollutants, the present chapter will provide an overview of recent trends in point source loadings into the Lower Fox River (i.e., the section downstream from Lake Winnebago).

In the following section we will present an historical review of water quality conditions in the Fox River and Southern Green Bay. In this discussion we will also present data with respect to loadings of various substances into the area of concern. Pre-1970 data was obtained from a

FIGURE 10
 DISTRIBUTION OF COMMERCIAL CATCH VALUE
 BY MAJOR SPECIES, SOUTHERN GREEN BAY

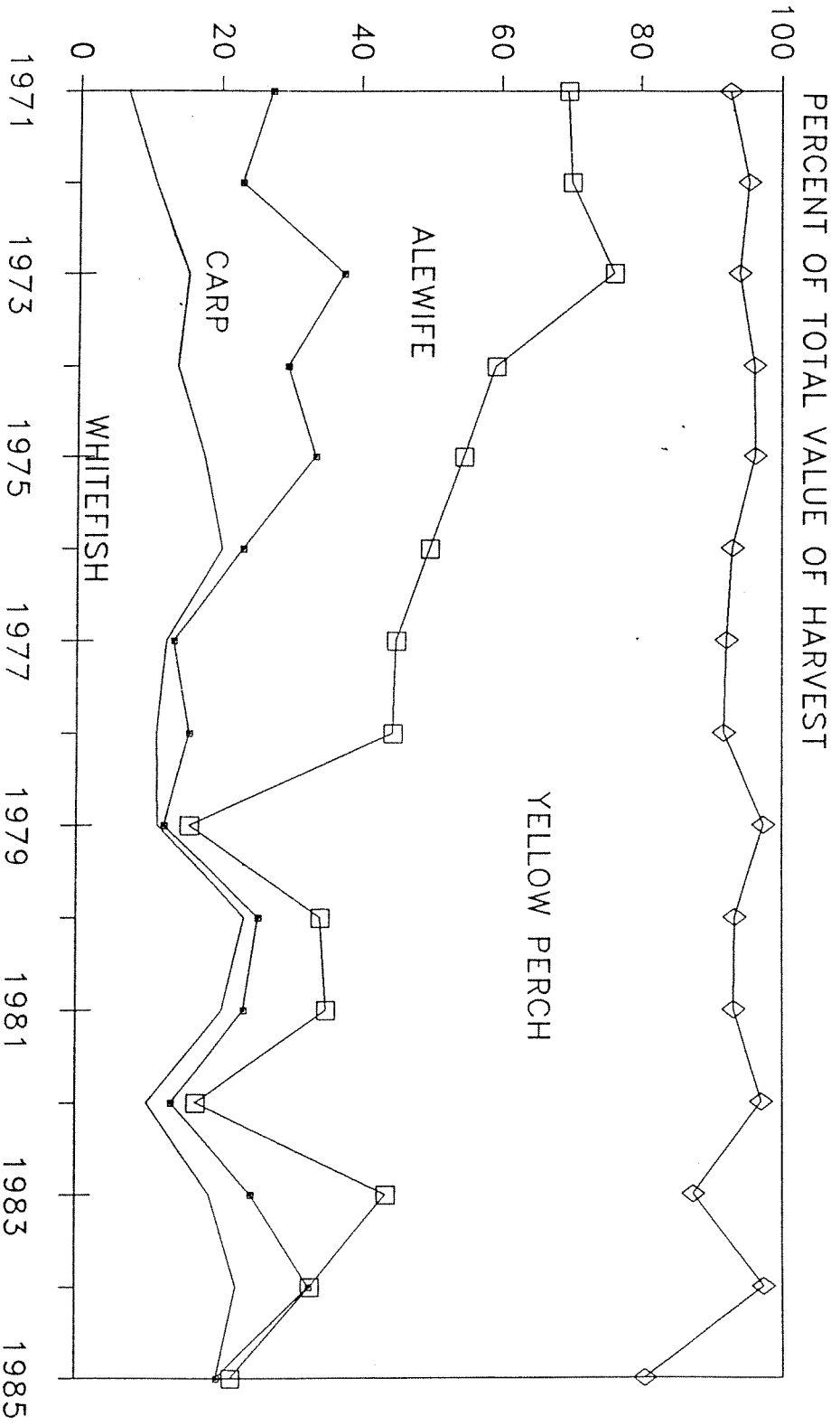

Source: Baldwin et al. (1979) and unpublished U.S. Fish and Wildlife Service data

Table 5. Average Discharge Rates of Water, Suspended Solids and Chlorides For Four Major Rivers Entering Green Bay, Early 1970's

River	Discharge		Suspended Solids			Chlorides		
	Rate (million m ³ /day)	%	Concen. (mg/l)	Net Transport (10,000 kg/d)	%	Concen. (mg/l)	Net Transport (10,000 kg/d)	%
Oconto	2.35	9.4	9.8	2.30	8.3	6.7	1.57	8.7
Menom- inee	8.96	36.0	5.3	4.75	17.2	1.4	1.25	6.9
Peshtigo	2.25	9.0	5.6	1.26	4.6	.6	1.35	5.5
Fox	11.3	45.4	17.1	19.3	69.9	12.3	13.9	76.8
Total	24.9	100.0	11.1	27.6	100.0	9.4	18.1	100.0

Source: Ahrnsbrak and Ragotzkie (1973)

review of published reports. For the post-1970 period, industrial point source loading data for BOD, solids, and various nutrients and toxic substances were obtained from unpublished WDNR NR-101 reports filed under the Wisconsin Pollution Discharge Elimination System (WPDES). After 1973, discharge data for municipal sewage treatment plants were obtained from unpublished monthly discharge monitoring reports submitted by the treatment plants to the WDNR.

2.2.1 Direct Discharges by Point Sources into the Lower Fox River

The loadings of industrial and municipal wastewater into the Fox River has had a long history (Harris et al., 1987 and Bertrand et al. 1976). Over the 1956-1986 period, the average effluent loadings into the Fox River was 146 million gallons/day (MGD) with a maximum effluent level of 190 MGD in 1971 (Figure 11). Except for the early 1970's, the level of effluent has remained relatively constant. In contrast to this trend, the source of these loadings has changed markedly. Before 1970, the pulp and paper industry accounted for 74 percent of the effluent (Figure 12). After 1973,

FIGURE 11
TOTAL POINT SOURCE EFFLUENT LOADINGS
TO THE LOWER FOX RIVER, 1956-86

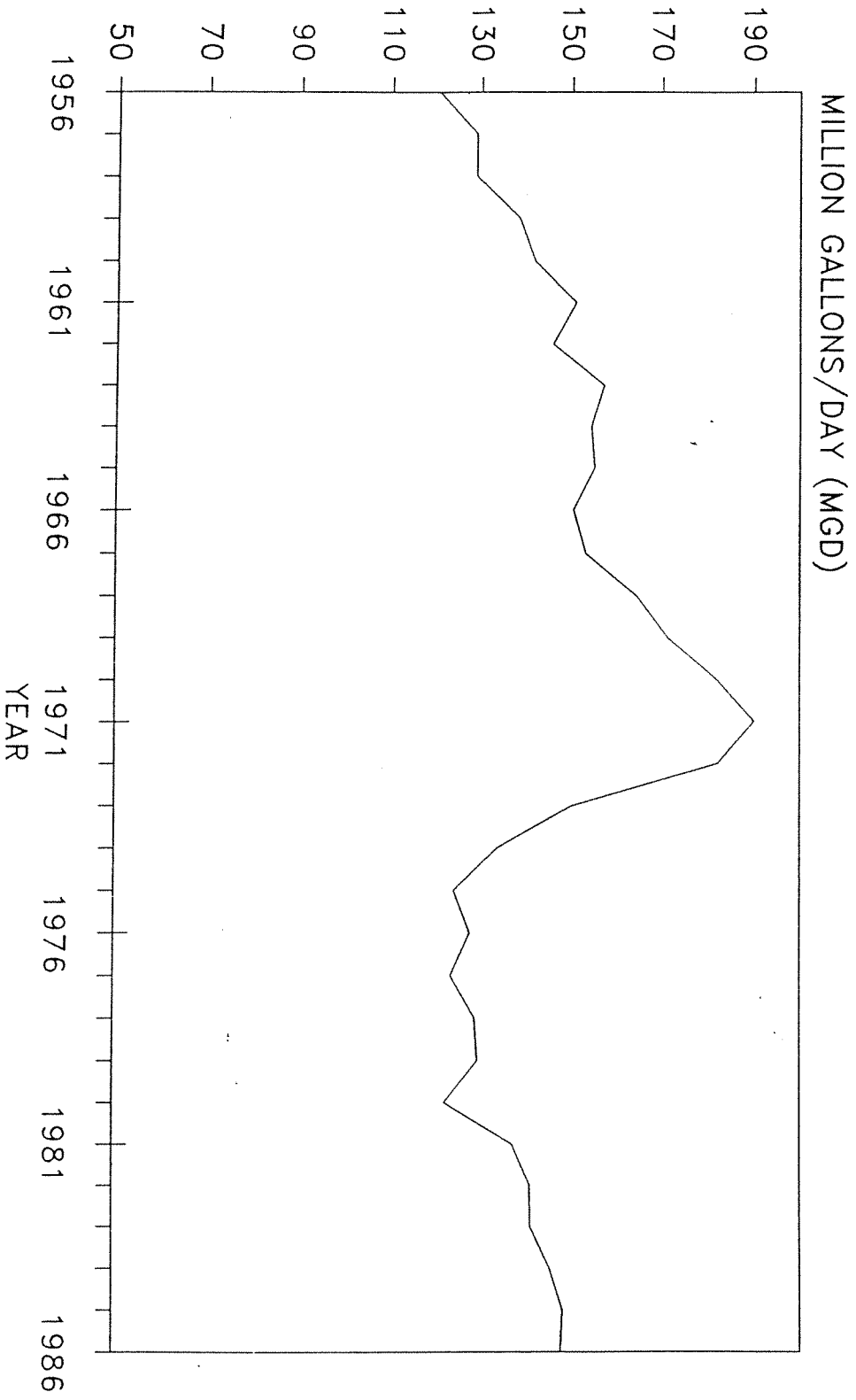

Source: Epstein et al. (1974) and unpublished WDNR data

FIGURE 12
PERCENT OF POINT SOURCE EFFLUENT FROM
PULP AND PAPER INDUSTRY, LOWER FOX RIVER

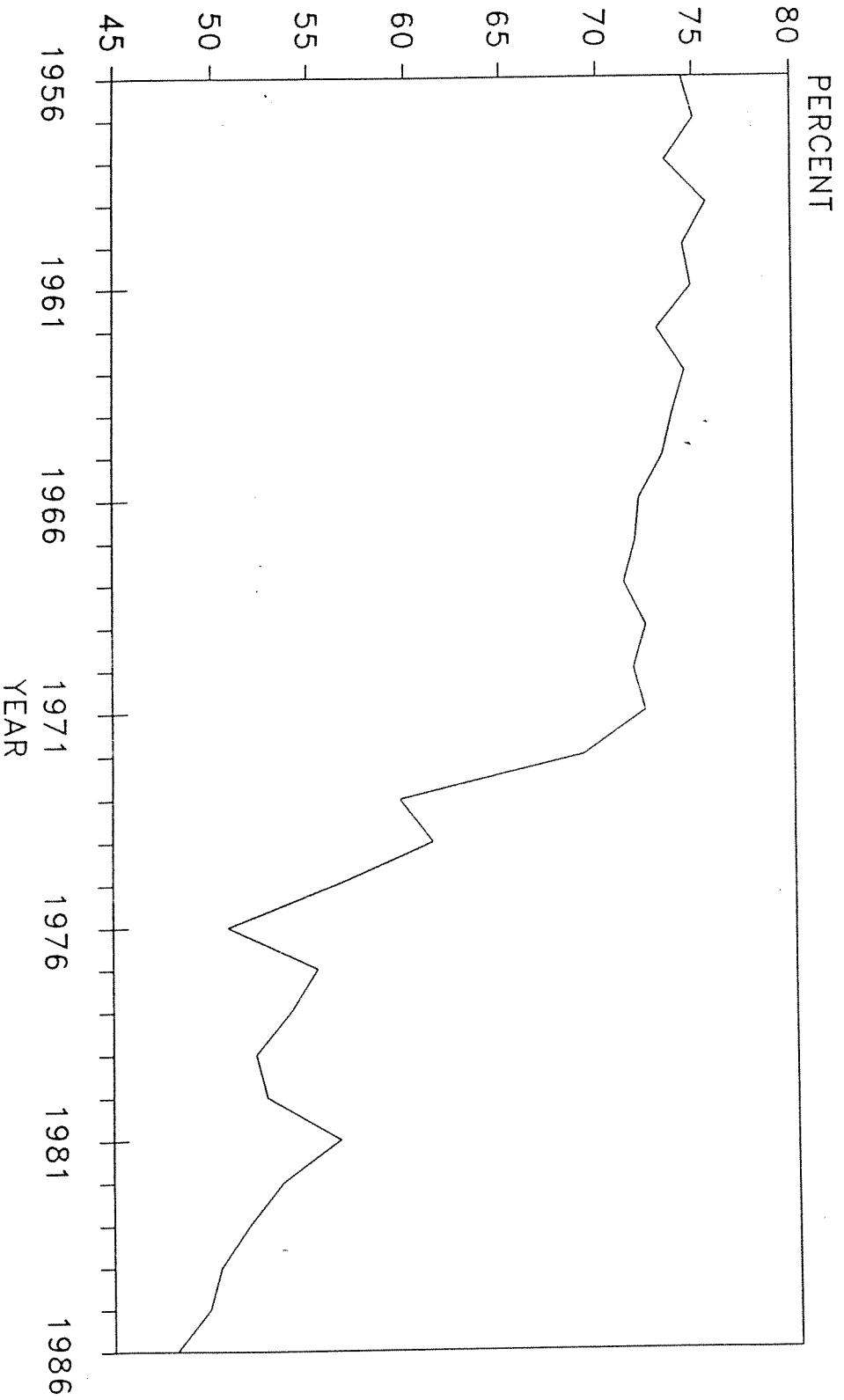

Source: Epstein et al. (1974) and unpublished WDNR data

and the passage of the 1972 Amendments to the Clean Water Act, this source accounted for an average of 54 percent of total discharge, with a low of 48 percent observed in 1986.

2.2.2 The Level of Point Source Loadings of BOD and Suspended Solids into the Lower Fox River and Southern Green Bay

The level of dissolved oxygen is often used as an indicator of water quality. Low oxygen levels indicate that an ecosystem has significant quantities of organic matter requiring large amounts of oxygen for decomposition. As stated in Bertrand et al. (1976), for Southern Green Bay, dissolved oxygen levels are determined primarily by the quality of the Fox River outflow. During the summer months, low oxygen levels are found along the entire length of the lower Fox River. Table 6 provides estimates of the level of dissolved oxygen for Southern Green Bay over the 1938-1982 period. This data shows an increase in dissolved oxygen levels at a time when increased pollution abatement activities were occurring.

During the early 1970's automatic monitoring equipment was installed at several sites in the lower Fox River. Figure 13 shows the change in the average dissolved oxygen levels at one of these monitoring sites for each year and for the three summer months, June, July and August. This data indicates an increase in the average dissolved oxygen levels over the 1971-1984 period similar to that observed in Table 6.

Such increases in dissolved oxygen are the result of much reduced BOD loadings. These reduced point source BOD loadings into the Fox River for the 1956-1986 period are shown in Figure 14. Prior to 1970, the average daily BOD loading was 325 thousand pounds/day with a maximum loading of over 400 thousand pounds/day in 1962. After 1973, the BOD averaged 56 thousand pounds/day. In the early 1970's the pulp and paper industry accounted for

FIGURE 13
DISSOLVED OXYGEN LEVELS AT THE
PROCTOR AND GAMBLE INTAKE, 1971-1984

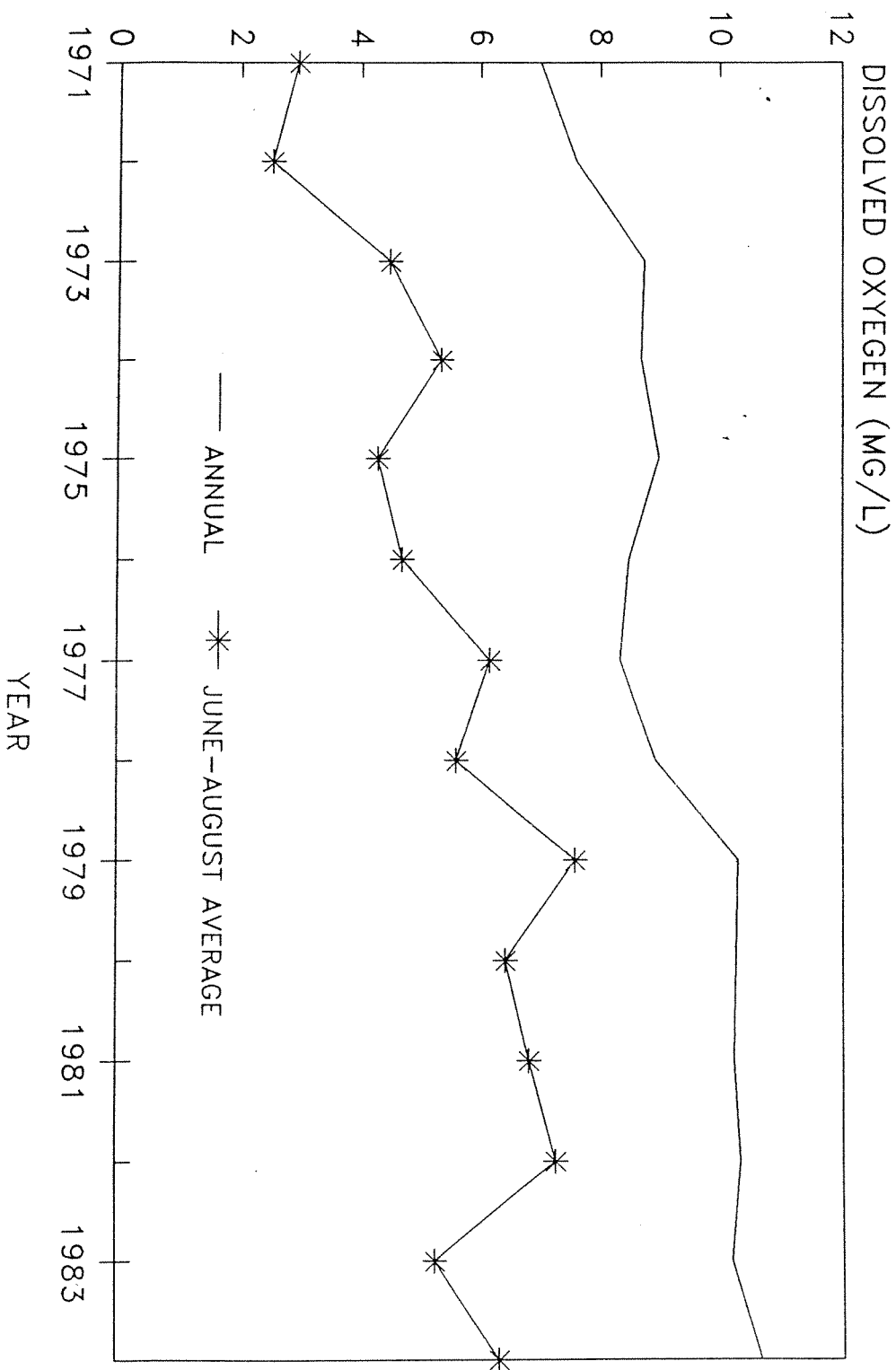

Source: Ball et al. (1985)

Table 6. Dissolved Oxygen Levels in Southern Green Bay, 1938-1982

Year	Dissolved Oxygen (mg/l)	Location	Time
1938-39	2 - 3	Fox River mouth	----
1955	.3 - 1.7	Between Fox River mouth and Grassy Island	----
1966	2.8	2.3 miles above Fox River mouth	July 5
	1.0	2.3 miles above Fox River mouth	August
	4.0	Fox River mouth	July 5
	< 1	Fox River mouth	August
1970	1.6	Mean of Eight Stations Southern Green Bay	Summer
1971	2.9	Mean of Eight Stations Southern Green Bay	Summer
1972	6.2	Mean of Eight Stations Southern Green Bay	Summer
1973	6.6	Mean of Eight Stations Southern Green Bay	Summer
1976	9.3	Mean of Eight Stations Southern Green Bay	Summer
1977	9.3	Mean of Eight Stations Southern Green Bay	Summer
1982	8.1	Mean of Eight Stations Southern Green Bay	Summer

Source: 1938-1966 Ball et al. (1985)

1970-1982 Harris et al. (1987)

FIGURE 14
POINT SOURCE BOD AND SUSPENDED
SOLID LOADINGS TO THE LOWER FOX RIVER

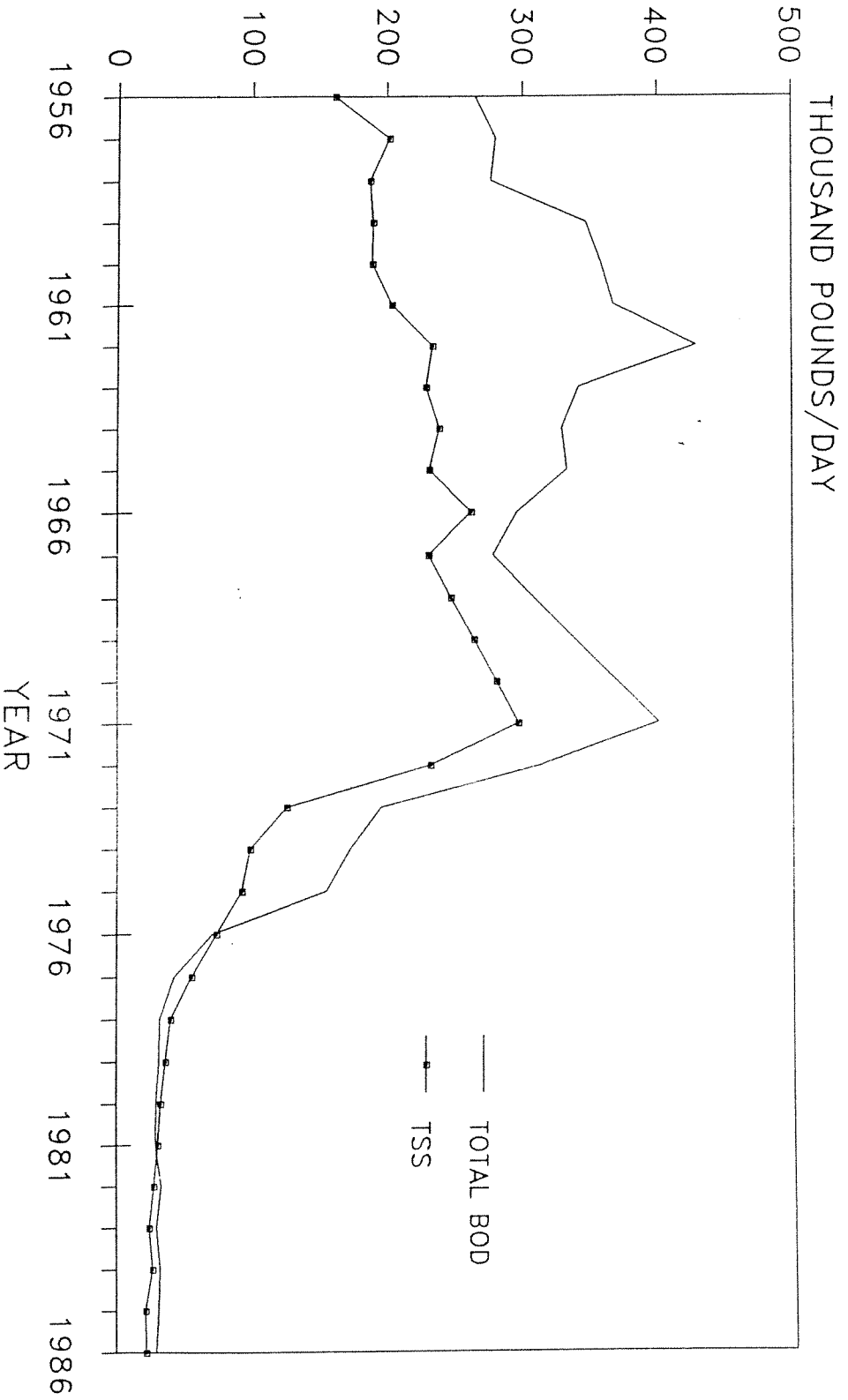

Source: Harris et al. (1987b) and unpublished WDNR data

more than 90 percent of the BOD (Harris et al., 1987). In Figure 15, we present the proportion of total BOD loadings that originates from pulp and paper point sources into the Fox River over the 30 year period, 1956-1986. Prior to 1973, the proportion of total loadings originating from the pulp and paper industry showed very little variation with a minimum value of 85 percent in 1972 and a maximum proportion of 94 percent in 1962. Since 1973, there has been a reduction in BOD loadings originating from the pulp and paper industry, which now accounts for between 55 and 65 percent of total BOD loadings.

Combining the trends in the total level of effluents deposited in the Fox River with BOD loadings, the concentration of BOD in the effluent were also found to decline significantly over the last thirty years (Figure 16). From Figure 16 the concentration of BOD in the effluent discharged by the pulp and paper industry into the Lower Fox River reached a maximum value of 3600 pounds/million gallons (MG) of effluent in 1962. Since then, the average pulp and paper BOD effluent concentration has declined to a value of less than 400 pounds/MG, an 89 percent decline. Between 1956 and 1970, the average pulp and paper BOD concentration was 2800 pounds/MG of effluent. After the early 1970's, the average BOD concentration decreased to 543 pounds/MG of effluent.

The BOD effluent concentration associated with municipal wastewater treatment plants (WWTP's) was relatively stable over the 1956-1971 period, declining from 867 pounds/MG in 1956 to 637 pounds/MG in 1971. Given the trends in loadings by municipal waste-water treatment facilities and the pulp and paper industry, overall BOD effluent concentrations of Fox River loadings decreased from slightly less than 2,900 pounds/MG of effluent in

FIGURE 15
PERCENT POINT SOURCE BOD AND TSS FROM
PULP AND PAPER INDUSTRY—LOWER FOX RIVER

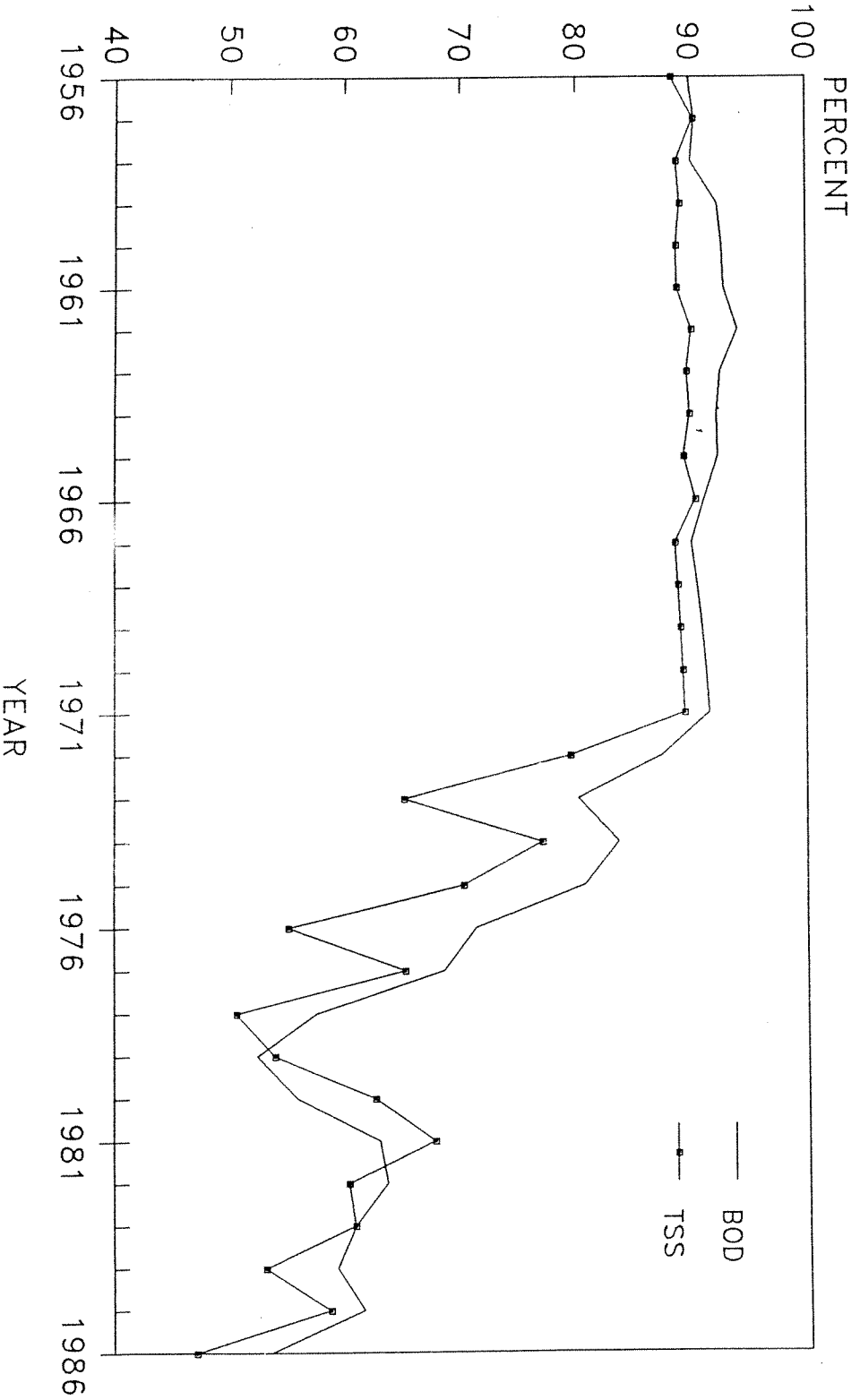

Source: Epstein et al. (1974) and unpublished WDNR data

FIGURE 16
CONCENTRATION OF BOD AND TSS IN PULP
AND PAPER EFFLUENT, LOWER FOX RIVER

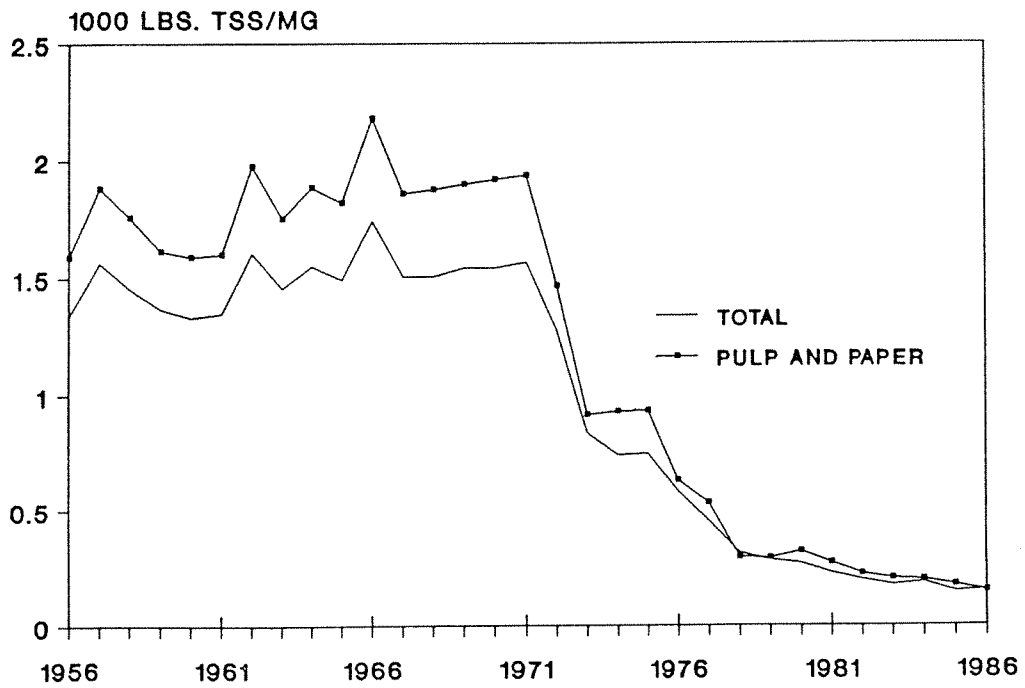
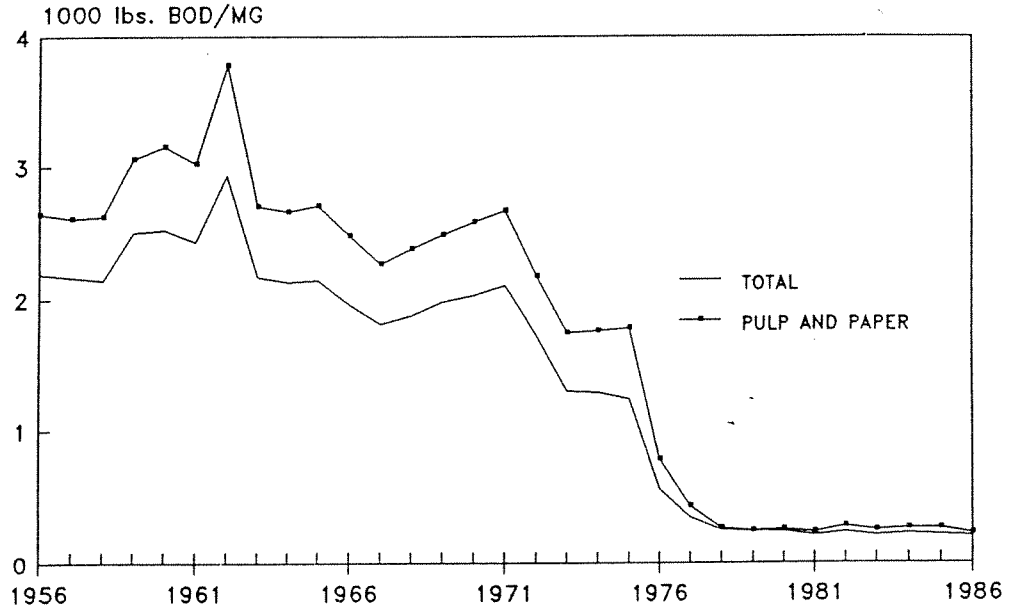

Source: Epstein et al. (1974) and unpublished WDNR data

1962 to 204 pounds/MG of effluent in 1986. Combining the trends observed in the pulp and paper industry and municipal WWTP's, between 1956 and 1970, the average BOD concentration in point source effluent was 704 pounds/MG. After 1973, the average total effluent BOD concentration was 264 pounds/MG of effluent.

Following the same trend as BOD loadings, the point source loadings of total suspended solids (TSS) into the Fox River has been dominated by the pulp and paper industry. The decreased TSS loadings observed since the early 1970's and the increased relative importance of municipal waste water treatment plants as a point source are shown by Figure 15. The pattern of reduced BOD concentration for both industrial and municipal point sources was followed in terms of the trend in the concentration of TSS (Figure 16). Over the 1956-1972 period, TSS effluent concentrations averaged 611 and 1799 pounds/MG of effluent for the pulp and paper industry and municipal WWTP sources, respectively. After the early 1970's, these coefficients had decreased to an average of 395 and 275 pounds/MG of effluent.

2.2.3 Point and Non-Point Loadings of Phosphorus into the Lower Fox River and Southern Green Bay

There is a marked trophic gradient in Green Bay with hypereutrophic conditions in the southern part and oligotrophic conditions in the Wisconsin's northern most portion. The loadings of phosphorus have historically resulted in large blooms of blue-green algae in the southern bay. A lack of oxygen in the bottom waters due to the decaying algae has at times, prohibited fish and other aquatic creatures from living there. In addition, fish habitat is disrupted due to the lack of underwater plants which have declined in abundance due to the algae induced lack of sunlight penetration. Increased nutrient levels also result in few predatory fish

such as walleye, bass and northern pike which assist in keeping the population of forage fish in check. Without these predators, Southern Green Bay has experienced an increase in the population of forage fish which eat most of the larger zooplankton. Zooplankton in turn, feed on algae and reduced populations of zooplankton has probably contributed to the increase in algae.

Most of the nutrient loadings to Green Bay come from the Lower Fox River, its tributaries and associated watersheds. Epstein et al. (1974) estimate that in the late 1960's and early 1970's, total annual loadings of phosphorus into Green Bay was over 4.7 million pounds. They estimated that over 80 percent of these loadings were supplied by point and non-point sources on the Fox-Wolf River system. In their analysis of this system, Sridharan and Lee (1975) estimated that less than 50 percent of total loadings originated from point sources.

The Nutrient and Eutrophication Technical Advisory Committee (TAC) of the Southern Green Bay RAP effort conducted an analysis of the sources of phosphorus into the Fox River system based on early 1980 conditions (WDNR, 1987a). It partitioned the Fox River system into two sections: (i) above and including Lake Winnebago and (ii) below Lake Winnebago on the lower Fox River. It estimated that there was a total loading of 1.2 million pounds of phosphorus into lower Green Bay (Table 7). Fifty-six percent of this loading originated from point and non-point sources in the drainage area above Lake Winnebago. One-fifth of total loadings originated from municipal WWTP's. Industrial point sources accounted for 13 percent of the loadings. Approximately 60 percent originated from non-point watershed sources.

The Nutrient and Eutrophication TAC extended their analysis to reflect

Table 7. Current and Projected Sources of Phosphorus Under Alternative Scenarios (pounds)

Source	Current		Year 2000						
	Percent	Status Quo	Scenario A	Percent of Decrease	Scenario B	Percent of Decrease	Scenario C	Percent of Decrease	
Lake Winnebago									
Municipal	50,860	4.4	51,400	34,900	5.8	21,700	6.5	34,900	4.9
Industrial	3,540	.3	22,100	1,000	7.4	300	4.8	300	6.4
Watershed	504,800	43.4	504,800	475,400	10.3	475,400	6.5	475,400	8.7
Atmospheric	25,700	2.2	25,700	25,700	----	25,700	----	25,700	----
Unaccounted	62,100	5.3	62,100	62,100	----	62,100	----	62,100	----
Total	647,000	55.6	666,100	599,100	23.5	585,200	17.8	598,400	20.0
Lower Fox River									
Municipal	181,100	15.6	273,500	141,500	46.4	35,900	51.8	141,500	38.9
Industrial	152,000	13.1	91,000	78,500	4.4	24,600	14.5	24,600	19.6
Watersheds	182,500	15.7	182,500	109,500	25.7	109,500	15.9	109,500	21.5
Total	515,600	44.4	547,000	329,500	76.5	170,000	82.2	275,600	80.0
Total	1,162,600	100.0	1,213,100	928,600	100.0	755,200	100.0	874,000	100.0

Source: WDNR, 1987a.

Note: The above table was constructed based on 1982, NR101 reports by industries and DMR's for municipal WWTP's. Watershed unit area loads are based on land use and type of soil. For each of the scenarios, it was assumed that a 40 percent reduction in watershed loadings could be achieved. For Scenarios A and C, it was assumed that the municipal WWTP's are required to meet a .5 mg/l phosphorus concentration limit on effluent. For Scenario B, this limit was assumed to be .1 mg/l. Industrial point sources were required to meet an effluent concentration limit of .5 mg/l under Scenario A. For Scenarios B and C, this limitation was set at .1 mg/l.

conditions for the year 2000 under a no-change scenario as well as three scenarios dealing with alternative phosphorus control options. By the year 2000, with no change in phosphorus controls, they projected a 4 percent increase in total phosphorus loadings. With the imposition of a .5 mg/L phosphorus effluent limitation on both industries and municipalities and a 40 percent reduction in watershed loadings (Scenario A), they estimated a 24 percent loadings reduction. More than half of this reduction was due to the reduced point source loadings on the lower Fox River. The impact of a .1 mg/L effluent limit on municipal WWTP's and industrial effluent (Scenario B) was projected to result in a 39 percent reduction with point sources on the Lower Fox River accounting for more than two-thirds of this reduction. With a .5 mg/L limit on WWTP's and a .1 mg/L limit on industrial effluent (Scenario C) was estimated to result in a 29 percent reduction over the status quo conditions with the Lower Fox River point sources accounting for 58 percent of this reduction.

In Table 7, the role of municipal WWTP's, the pulp and paper industry, and the watersheds on the Fox River system as sources of phosphorus loadings is presented. Using the early 1980 data, there was found to be a major difference between the role of point and non-point sources for the area above Lake Winnebago and the lower Fox River. Phosphorus loadings to Lake Winnebago is dominated by non-point watershed sources (78 percent). In contrast, there is a fairly even split between the watershed, municipal WWTP's and industrial point sources on the Lower Fox River.

Using NR-101 reports for industrial discharges and monthly DMR's for municipal WWTP's we were able to examine the changes in industrial and municipal phosphorus loadings into the Lower Fox River for the 1971-1986

period (Figure 17). After the passage of the 1972 Amendments to the Clean Water Act there was a substantial drop in the total phosphorus loadings from point sources. The level of industrial phosphorus loadings has remained relatively constant at 100,000-120,000 pounds/year. In contrast, the level of municipal loadings has decreased from the 1971 level of more than 750,000 pounds/year to less than 165,000 pounds/year in 1986 resulting in a decrease in the proportion of total point source phosphorus loadings associated with WWTP's from a high of over 90 percent in 1973 to approximately 60 percent over the last five years (Figure 18).

Concurrent with the drop in total phosphorus loadings, phosphorus effluent concentrations have also dropped over the last fifteen years (Figure 19). In 1971, municipal loadings were at a rate of 40 pounds/MG of effluent. This decreased 87 percent to slightly more than 6 pounds/MG in 1986. Not surprisingly, prior to 1978, the pulp and paper effluent concentrations were relatively constant at a level substantially below those observed for municipal WWTP's. Since 1978, the trend in the industrial coefficients paralleled that which was occurring on the municipal side. In terms of the total effluent phosphorous concentrations, over the 1971-1986 period, they were reduced by approximately two-thirds from slightly more than 17 pounds/MG to 5 pounds/MG of effluent.⁸

The city of Green Bay has historically accounted for a large proportion of the point source loadings of phosphorus into the Fox River. Table 8, shows the average annual loadings of effluent, TSS, BOD and phosphorus for all municipal WWTP's into the Fox River. Prior to 1975, the Green Bay WWTP

⁸Unfortunately we were not able to isolate the role of secondary waste treatment vs. the ban on phosphate detergents in this reduction.

FIGURE 17
 PHOSPHORUS LOADINGS BY POINT SOURCES
 INTO THE LOWER FOX RIVER

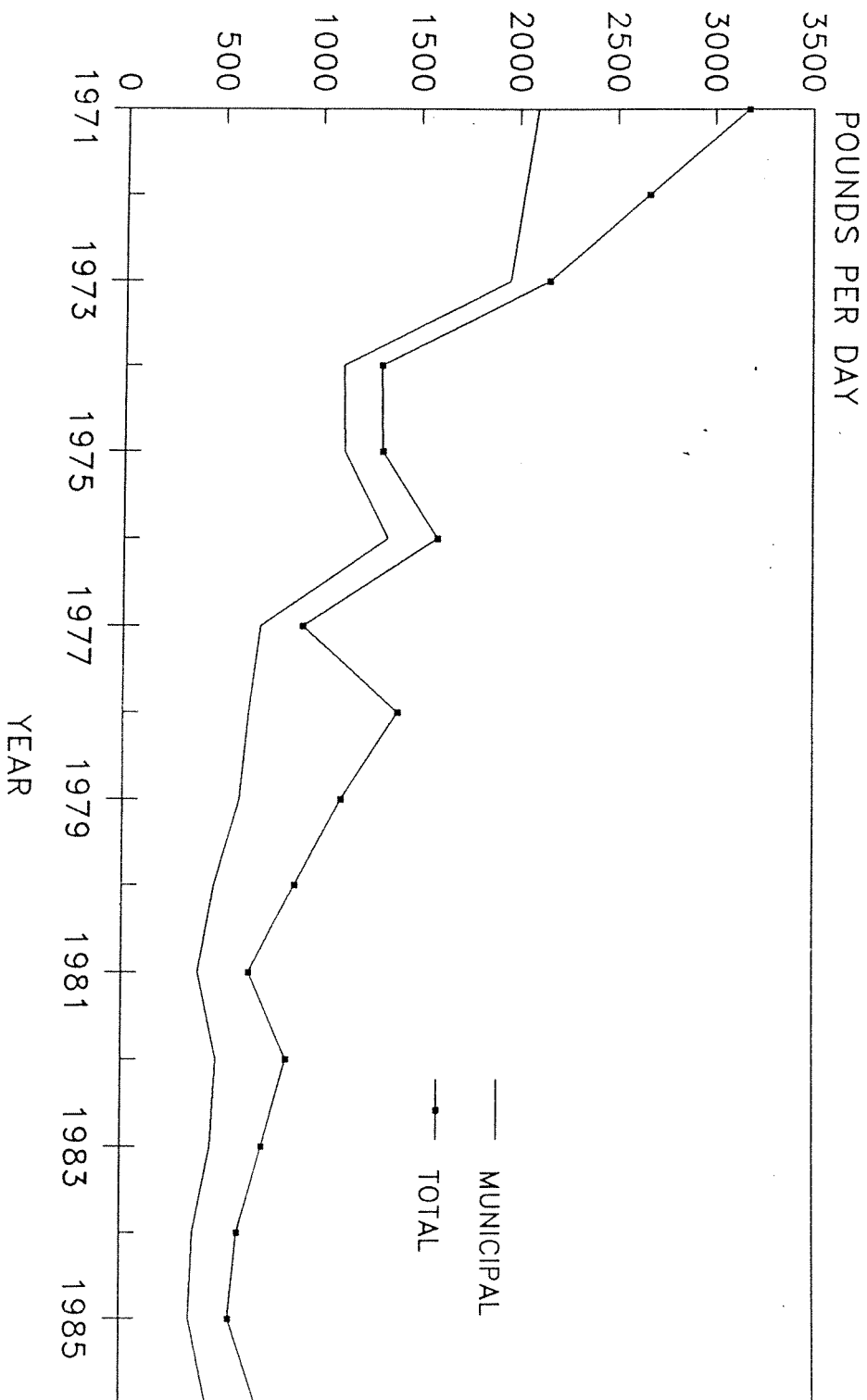

Note: Total-Municipal = Pulp & Paper
 Source: Epstein et al. (1974) and unpublished WDNR data

FIGURE 18
PHOSPHORUS LOADINGS FROM MUNICIPAL
WASTE TREATMENT PLANTS--LOWER FOX RIVER

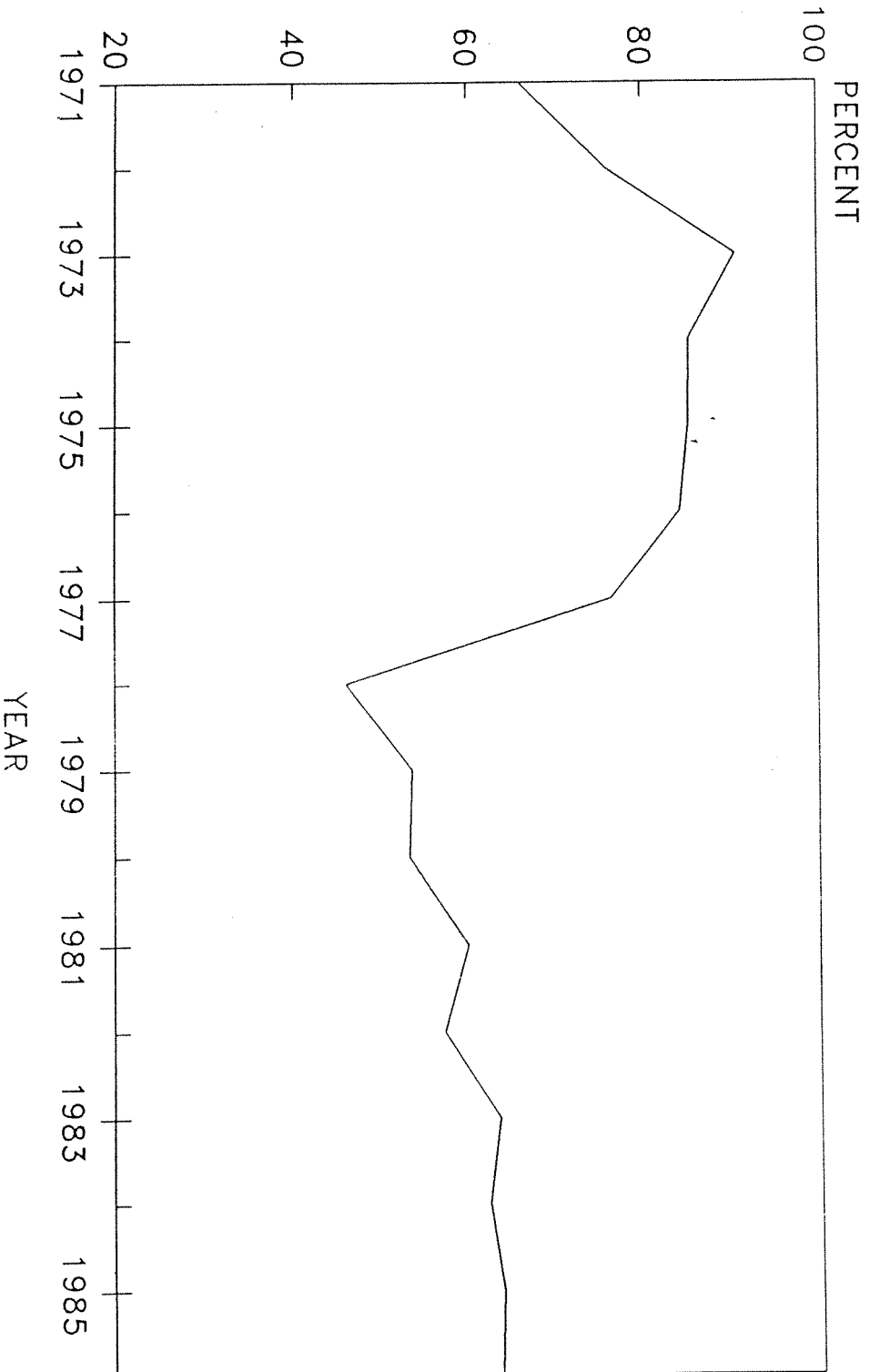

Source: Epstein et al. (1974) and unpublished WDNR data

FIGURE 19
PHOSPHORUS CONCENTRATION IN POINT
SOURCE EFFLUENT, LOWER FOX RIVER

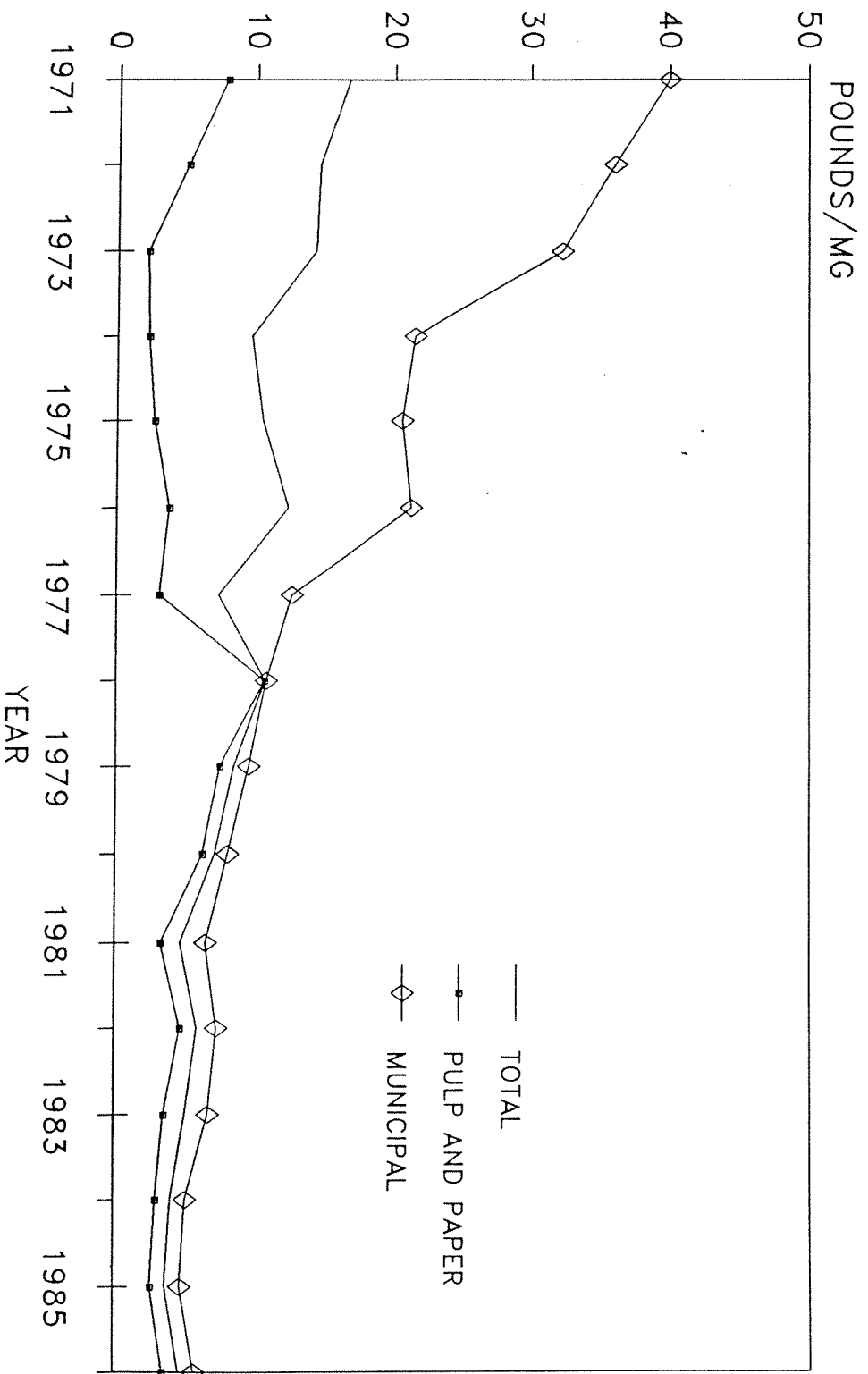

Source: Epstein et al. (1974) and unpublished WDNR data

Table 8. Mean Daily Loadings of BOD, TSS and Total Effluent by Green Bay Metropolitan Sewage District to the Lower Fox River, 1956-1986

Year	Green Bay				Total Municipal			
	BOD (000 lbs)	TSS (000 lbs)	Effluent (MGD)	Phos (lbs)	BOD (000 lbs)	TSS (000 lbs)	Effluent (MGD)	Phos (lbs)
1956-1965	10.9	9.1	12.4		26.0	21.9	36.6	
1966-1975	19.5	12.1	18.3		31.3	30.9	50.6	
1976-1986	7.2	6.7	34.4		13.7	15.1	65.0	
1956-1986	13.0	9.3	26.7		23.3	22.4	51.2	
1971-1976				1171				1610
1977-1986				198				493

Source: 1956-1973, Epstein et al. (1974)
1974-1986, WDNR, 1974-1986

accounted for approximately one-third of the total municipal effluent loading. After 1975, this percentage had increased to 53 percent. In contrast to the trends observed in terms of total effluent, the proportion of suspended solids associated with Green Bay has remained relatively constant at 40 percent of the total. BOD, on the other hand increased dramatically due to the two pulp and paper mills using the Green Bay WWTP. For 1956-1965, 42 percent of total municipal BOD loadings into the lower Fox River was accounted for by the city of Green Bay. Over 1966 to 1975, this increased to 62 percent. Over the last ten years this decreased to 53 percent. Prior to substantial reductions in phosphorus loadings, Green Bay accounted for close to three-quarters of total phosphorus. This has decreased to 40 percent since 1977.

2.2.4 Loadings of PCBs and Other Substances into the Lower Fox River and Southern Green Bay

The presence of toxic substances are a major problem in Southern Green

Bay RAP, notes that "...over 100 toxic substances including 37 priority pollutants and 11 different resins and fatty acids were identified in the discharges from 14 pulp and paper mills and 5 major municipal sewage treatment plants" (WDNR, 1987b, p.3). In the previous sections we presented an overview of the loadings of suspended solids, BOD, and phosphorus for both the industrial and municipal point sources into the Fox River by the pulp and paper industry. In the present section we will present a brief discussion of the loadings of other substances into the Fox River.

The loadings of toxic substances is particularly important to the Green Bay sport and commercial fisheries. According to recent fish consumption advisories that have been issued by the State of Wisconsin, contaminated fish in Southern Green Bay include carp, lake trout, walleyes, catfish, white suckers, bass and northern pike. Table 9 presents the 1987 Wisconsin Fish Advisory for Southern Green Bay along with the state's health standards for fish contamination.

Using 1983 data, the Toxic Substances TAC estimated that the Fox River contributed over 60 percent of total tributary loadings of PCBs to Lake Michigan while Green Bay represents only 1.4 percent of Lake Michigan's water volume. These estimates include PCBs loadings from existing point sources and from contaminated sediments in the river.⁹ Fox River PCB loads to Green Bay were estimated to be in the range of 500-600 kg/year.

As noted in their report, a major concern with respect to PCBs is that this substance does not readily degrade and as a result has a relatively

⁹No information could be obtained with respect to the role of landfills and other nonsediment sources of PCBs to the lower Fox River.

Table 9. 1987 Wisconsin Fish Consumption Advisory for Green Bay and the Lower Fox River

Region	Group 1	Group 2	Group 3
Green Bay	Rainbow Trout ≤ 16" Chinook Salmon ≤ 25" Brook Trout ≤ 15" Northern Pike ≤ 28" Perch Walleye ≤ 20" Brown Trout ≤ 12" Bullhead	Splake ≤ 16"	Rainbow Trout ≥ 22" Chinook Salmon ≥ 25" Brown Trout ≥ 12" Brook Trout ≥ 15" Carp* Splake ≥ 16" Northern Pike ≥ 28" Walleye ≥ 20" White Suckers White Bass*
Lower Fox River to De Pere Dam			White Bass* Walleye Carp* White Sucker
Lower Fox River from De Pere to Neenah-Menasha	White Bass Walleye ≥ 15" Northern Pike Perch White Sucker	Walleye ≥ 15" Bullheads	Carp ≥ 17"

Source: WDNR 1987b.

- Group 1: Contaminant levels in 10 percent or less of tested fish are higher than one or more health standards. Eating Group 1 fish poses the lowest health risk. Recommended to trim fat and skin from fish before cooking and eating.
- Group 2: Contaminant levels in more than 10 percent but less than 50 percent in fish tested. Children under 15, nursing mothers, pregnant women and women who anticipate bearing children should not eat these fish.
- Group 3: Contaminant levels in 50 percent or more of fish test are higher than one or more health standards. No one should eat fish in this category.

*Ninety percent or more Group 3 fish contain contaminant levels higher than one or more health standards.

U.S. FDA and Wisconsin Division of Health Standards for Contaminants in Fish:

PCBs	2 PPM
DDT	5 PPM
Toxaphene	5 PPM
Chlordane	.3 PPM
Dieldrin	.3 PPM
Mercury	.5 PPM
Dioxin	50 PPT

long half-life. For 1982, the WDNR estimated that point sources accounted for less than 10 percent of the total PCB loadings from the Fox River system to Green Bay. The remainder of the loadings originated from contaminated sediments. The WDNR estimated that the point sources deposited a maximum of 77 pounds of PCBs in the surface water in that year.

The PCB point source loadings into the Lower Fox River are primarily the result of wastepaper recycling. In terms of the concentration of PCBs in the bay's water, Swackhamer and Armstrong (1987) analyzed the presence of PCBs in Lake Michigan and Green Bay in September, 1980. They found that PCB concentrations are highest in Southern Green Bay and decrease with increasing distance from the mouth of the Fox River (Figure 20).

Using Wisconsin Pollution Discharge Elimination System effluent report forms, point source loadings of PCBs by the pulp and paper industry over the 1973-1986 period was estimated (Figure 21). Over this time period there has been a dramatic decrease from over 400 pounds/year to less than 20 pounds/year. Given the stable nature of PCBs once they have been absorbed in the upper layers of sediment, these contaminated sediments act as sources of PCBs for many years following the initial deposition. After taking into account this resuspension of PCB's, the reductions in total system loadings are less than new point source loadings.

Besides data on PCB loadings, we collected available data on several other substances contained in the effluent of the pulp and paper industry over the 1973-1986 period. Figure 22, shows the trend for the loadings of lead, magnesium, nickel and phenols.¹⁰

¹⁰Phenols are caustic poisonous acidic compounds present in coal and wood tar and used as a disinfectant and in making plastics.

Figure 20: PCB Concentration and Distance From the Mouth of the Fox River

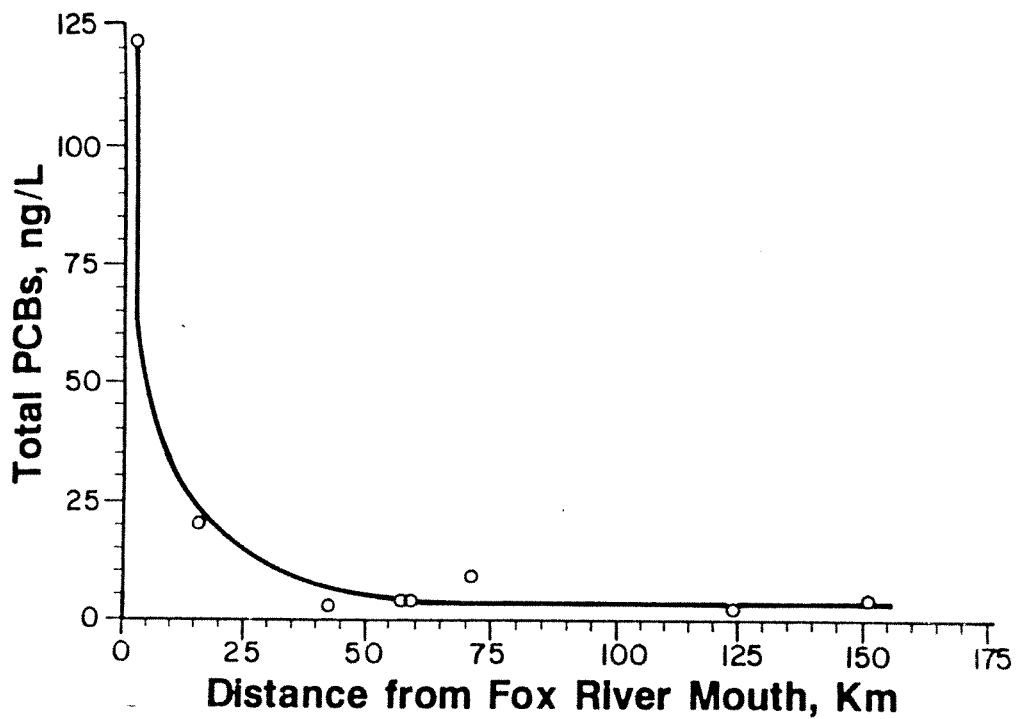

Source: Swackhammer and Armstrong (1987)

FIGURE 21
PCB LOADINGS BY THE PULP AND PAPER
INDUSTRY, LOWER FOX RIVER

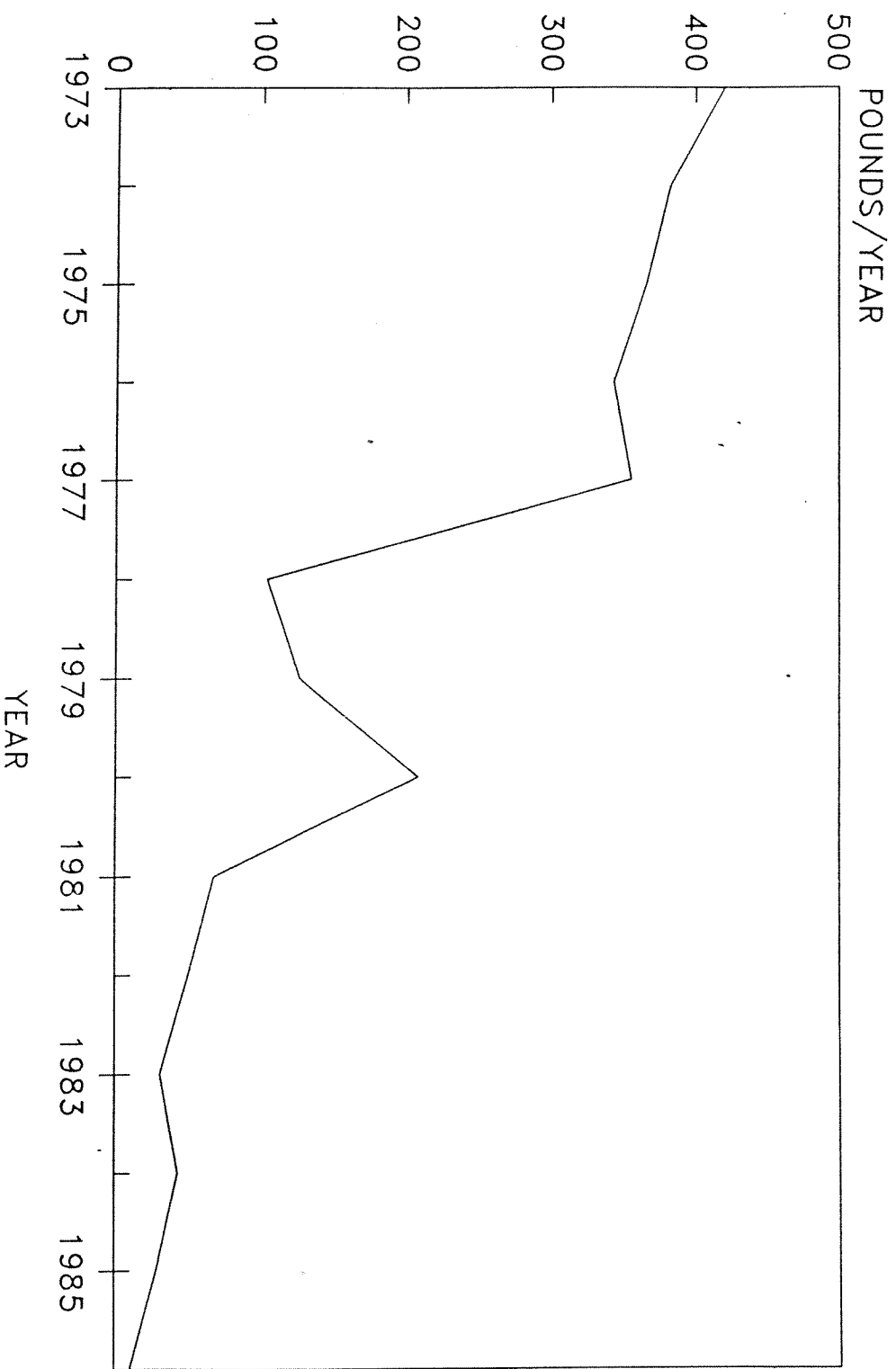

Source: Unpublished WDNR data

FIGURE 22
PULP & PAPER MILL POINT SOURCE LOADINGS
OF TOXIC MATERIALS, LOWER FOX RIVER

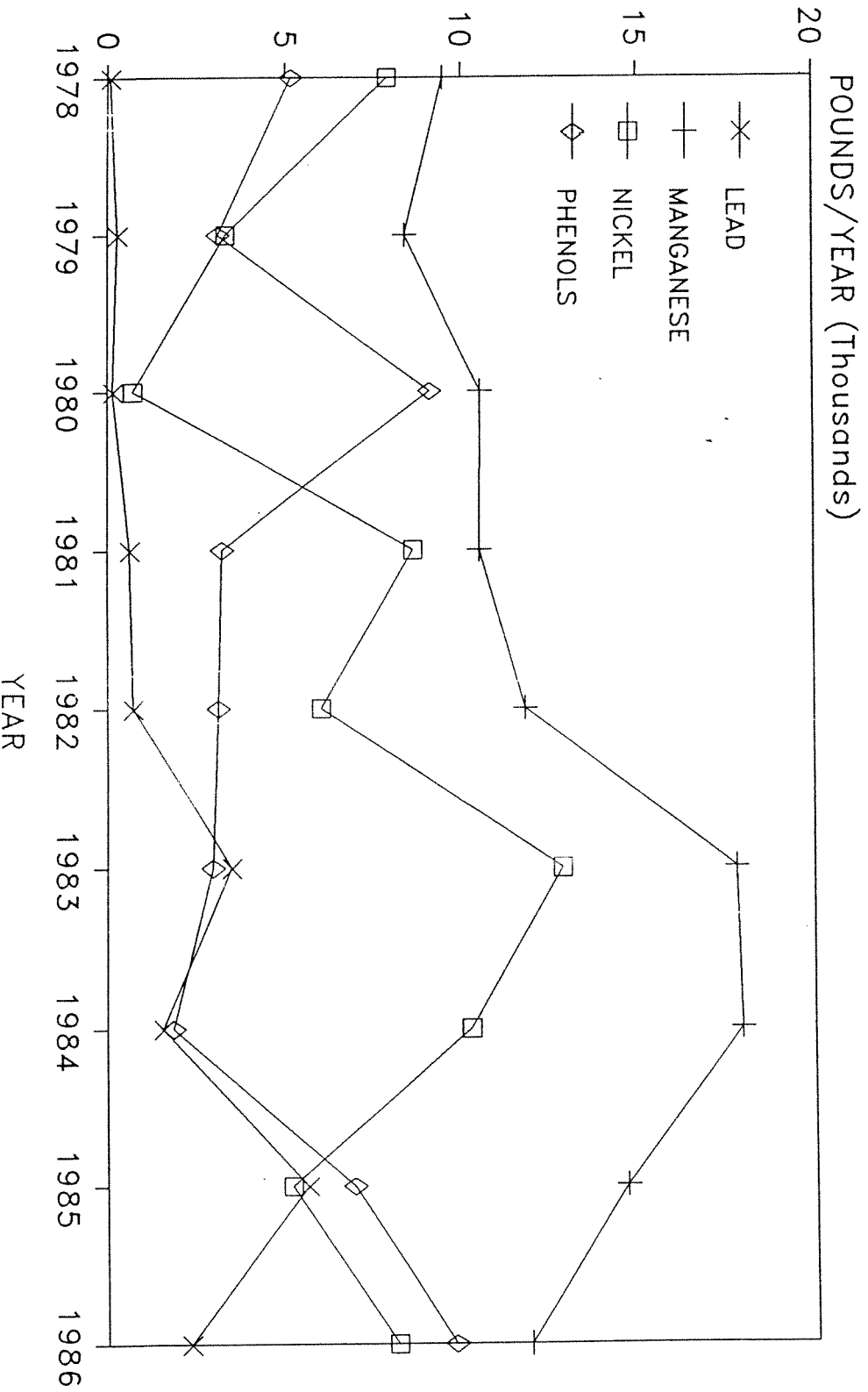

Source: Unpublished WDNR data

III. Expenditures for Water Pollution Control By the Pulp and Paper Industry and Municipalities on the Lower Fox River

In previous sections of this report we examined the level of BOD, TSS and phosphorus loadings from municipal WWTP's and the pulp and paper industry on the Lower Fox River and Southern Green Bay. In the present section we present an overview of the expenditures undertaken by these sources of industrial and municipal effluent that have directly affected the level of water quality in Southern Green Bay. Unpublished WDNR data is used in the analysis of both the pulp and paper industry and the WWTP's located on the Lower Fox River.

3.1 Expenditures for Water Pollution Control in the Fox River Region by the Pulp and Paper Industry

In 1986, Wisconsin had 49 pulp and paper mills. Hence, Wisconsin ranked second among all states both in terms of the number of producing units and pulp production. The Lower Fox River possesses the world's highest concentration of pulp and paper mills (19 mills) which accounts for approximately 40 percent of the state's production capacity (Table 10). Fourteen of these plants discharge directly into the Fox River. Over half of the state's capacity of pulp mills using recycled materials are located on the Lower Fox River. This is important given the PCB problem associated with the recycling of paper for pulp production (Sullivan and Delfino, 1982, p.48).

Pulp and paper production are both capital and water intensive. Large volumes of water are withdrawn, used in the production processes, and returned to the source after treatment or discharged to a municipal waste water treatment plant. On average, over 32 thousand gallons of water are required to produce a ton of paper products (Wisconsin Paper Council, 1986).

Table 10. Number and Daily Capacity of Wisconsin Paper Mills, 1980

	Wisconsin		Lower Fox River		% of State
	Plants	Capacity (tons)	Plants	Capacity (tons)	
Pulp Mills	52	7,965	15	2,942	36.9
Wood	26	5,335	7	1,487	27.9
Recycled	21	2,550	5	1,385	54.3
Rag	5	80	3	40	50.0
Paper and Paperboard Mills	52	11,917	19	5,084	42.7

Source: Sullivan and Delfino (1982)

Loehr and Prey (1987) report that in 1984, approximately 3.75 million tons of paper were produced in Wisconsin, requiring 120 trillion gallons of water. In 1986, the pulp and paper mills on the Lower Fox River required 62.8 million gallons/day (Lockwoods Directory, 1987).

Using unpublished WDNR data we were able to estimate water pollution control expenditures undertaken by the pulp and paper industry in the Lower Fox River area (Loehr and Prey, 1987). That data was collected by the Department of Revenue as part of a Wisconsin program of property tax exemption for new structures built for water and air pollution control. As stated in the Wisconsin statutes, eligible exemptions include all property purchased or constructed as a waste treatment facility for industrial waste. Not included in this data are those industries that convert paper into various products without actually producing pulp and paper. Also excluded, if any, would be pulp and paper mills that do not claim their expenditures as a property tax exemption.

Loehr and Prey (1987) provide an overview of the importance of pollution control expenditures relative to total capital projects for the Wisconsin pulp and paper industry. Since the mid-1970's there has been a relative decline in the ratio of pollution control/total capital expenditures from 24

percent over 1977-1979 to less than 10 percent over the 1985-1987 period for the Wisconsin industry as a whole. As the authors note, this decline can probably be explained by the capital expenditures occurring as the industry made investments in order to meet the requirements of the 1972 Amendments to the Clean Water Act.

Over the 1972-1975 period, pollution control operating and capital expenditures undertaken by the paper industry in Wisconsin has been estimated to have been over \$107 million (Bertrand et al. 1976, p. 203). Using the above Department of Revenue property tax exemption data, we estimated water pollution control capital expenditures by the pulp and paper industry located in the Fox River region over the 1975-1987 period (Figure 23). For the pulp and paper industry on the Lower Fox River, since the decline from 1975 levels, pollution control capital expenditures have remained relatively constant at approximately \$3.5 million. Total water pollution control capital expenditures over this 13 year period was \$62.4 million.

The above discussion has been concerned with capital related expenditures for pollution control. Region-specific operating and maintenance costs are not as readily available. The Wisconsin Paper Council estimates that over the 1976-1986 period total operating and maintenance expenditures for the state-wide industry was \$340 million. This represents an average annual expenditure of \$30.9 million. Multiplying this annual expenditure by the proportion of total production capacity associated with mills on the lower Fox River, results in an estimate of \$11.4 million as the annual operating and maintenance costs for pollution control.

FIGURE 23
WATER POLLUTION CAPITAL EXPENDITURES
BY THE FOX RIVER PULP AND PAPER INDUSTRY

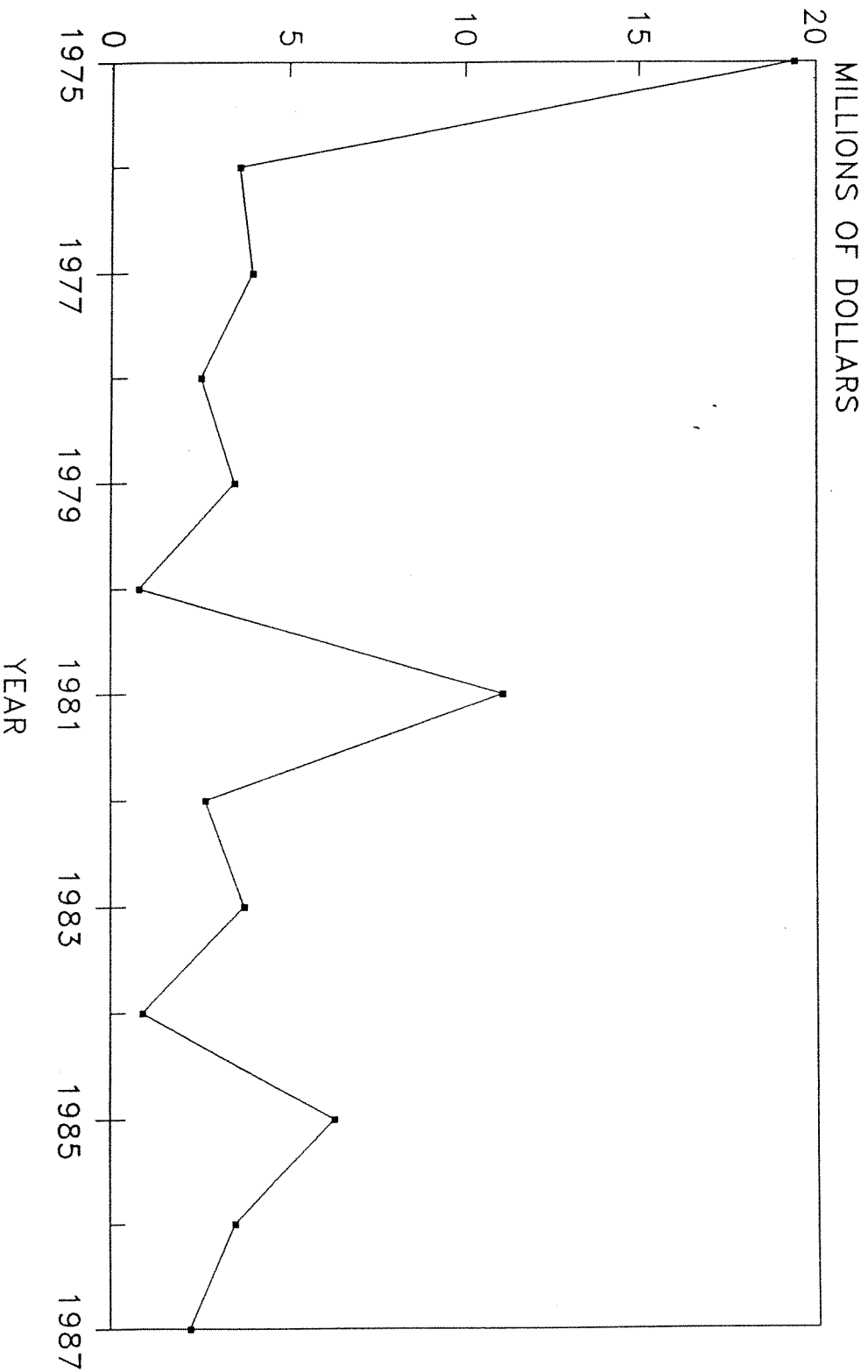

Source: Loehr and Prey (1987)

3.2 Past Expenditures for Waste Water Treatment by Municipalities On the Lower Fox River

The Federal Water Pollution Control Act passed in 1956 made available grants to pay for 50 percent of the cost of building municipal wastewater treatment plants. The Water Quality Act of 1965 set the first national water quality standards and gave the states responsibility for monitoring these standards. The 1972 amendments to the Water Quality Act increased the federal cost sharing to 75 percent of construction costs. In the state of Wisconsin, the WDNR administers the federal grant program.

When it became clear that federal funding would be insufficient to meet the 1983 goals of the 1972 amendments, the State of Wisconsin created the Wisconsin Fund out of general purpose revenue funds to provide financial assistance for the planning and construction of new wastewater treatment facilities or the upgrading of existing plants. This fund is supplemental to the federal program and provides 60 percent cost-sharing for these expenditures.

If a community has a wastewater treatment problem, the first step in obtaining state or federal funding is to put the community's project into a priority system. Six factors determine how the WDNR ranks a community's need. These factors are: (i) the river basin where the plant is to be located, (ii) whether there currently exists a health hazard, (iii) the ability of the area's water resource to absorb pollutants, (iv) the necessity of the community to control nutrient loadings to receiving waters, (v) existing population in the community, and (vi) the type of project involved (WDNR, 1983). Once a community's project is on the priority list, there is a three stepped procedure for completing the project with separate funding requests required for each step: (i) planning, (ii) design of plant, and (iii) construction.

Data from the WDNR was obtained with respect to federal and state pollution control grants for the 1973-1987 period. Over this period, a total of \$84 million in state and federal grants were given in the Lower Fox River region (Table 11). This level of grants resulted in a total expenditure of \$113 million. For the Green Bay watershed as a whole, \$196 million in grants were distributed resulting in a total expenditure of \$283 million. Over 96 percent of the total grants originated from federal sources in the Fox River region compared to 67 percent in the Green Bay watershed and 54 percent for the state as a whole.

In addition to the amounts reported in Table 11, Harris et al (1987) notes that over the 1970-1973 period, the Green Bay Metropolitan Sewage District expended over \$80 million for a new activated sludge plant designed to receive all local municipal waste water as well as the pulp mill waste from two pulp and paper mills (Harris et al., 1987 p.62).

Annual operating and maintenance expenditures for the municipal WWTP's operating on the Lower Fox River were obtained from unpublished data collected by the Wisconsin Department of Revenue. Figure 24 shows these expenditures for operation and maintenance over the 1973-1987 period. In nominal terms, there has been an increase from \$4.7 million in 1973 to over \$24 million in 1986. In real terms (i.e., inflation adjusted), the level of expenditures has remained relatively constant after 1976 at \$10 million (1973 \$).

3.3 Summary of Historical Expenditures for Point Source Water Pollution Control in the Lower Fox River Region

The previous discussion has presented an overview of historical capital and annual operating expenditures for water pollution control by

Table 11. Total Water Quality Control Grants and Associated Expenditures:
Wisconsin, Green Bay and the Lower Fox River, 1973-1987

Category of Grant	Grant Amount (000 dollars)	Community Share (000 dollars)	Total (000 dollars)
Wisconsin			
Federal Step 1	121,407	40,469	161,876
Federal Step 2	33,641	11,214	44,855
Federal Step 3	740,545	246,848	987,393
Sub-Total	895,593	298,531	1,194,124
Wisconsin Step 1	1,772	591	2,363
Wisconsin Step 2	12,589	4,196	16,785
Wisconsin Step 3	752,709	501,806	1,254,515
Sub-Total	767,070	506,593	1,273,663
Total	1,662,663	805,124	2,467,787
Green Bay Watershed			
Federal Step 1	5,701	1,900	7,601
Federal Step 2	8,615	2,871	11,486
Federal Step 3	117,181	39,061	156,242
Sub-Total	131,497	43,832	175,329
Wisconsin Step 1	788	262	1,050
Wisconsin Step 2	967	322	1,289
Wisconsin Step 3	63,090	42,059	105,149
Sub-Total	64,845	42,643	107,488
Total	196,342	48,095	282,817
Fox River Valley			
Federal Step 1	1,523	508	2,031
Federal Step 2	1,626	542	2,168
Federal Step 3	78,025	26,008	104,033
Sub-Total	81,174	27,058	108,232
Wisconsin Step 1	490	164	654
Wisconsin Step 2	247	82	329
Wisconsin Step 3	1,978	1,319	3,297
Sub-Total	2,715	1,565	4,280
Total	83,889	33,503	112,512

Source: WDNR, 1988.

FIGURE 24
OPERATING AND MAINTENANCE EXPENDITURES
BY WASTEWATER PLANTS, LOWER FOX RIVER

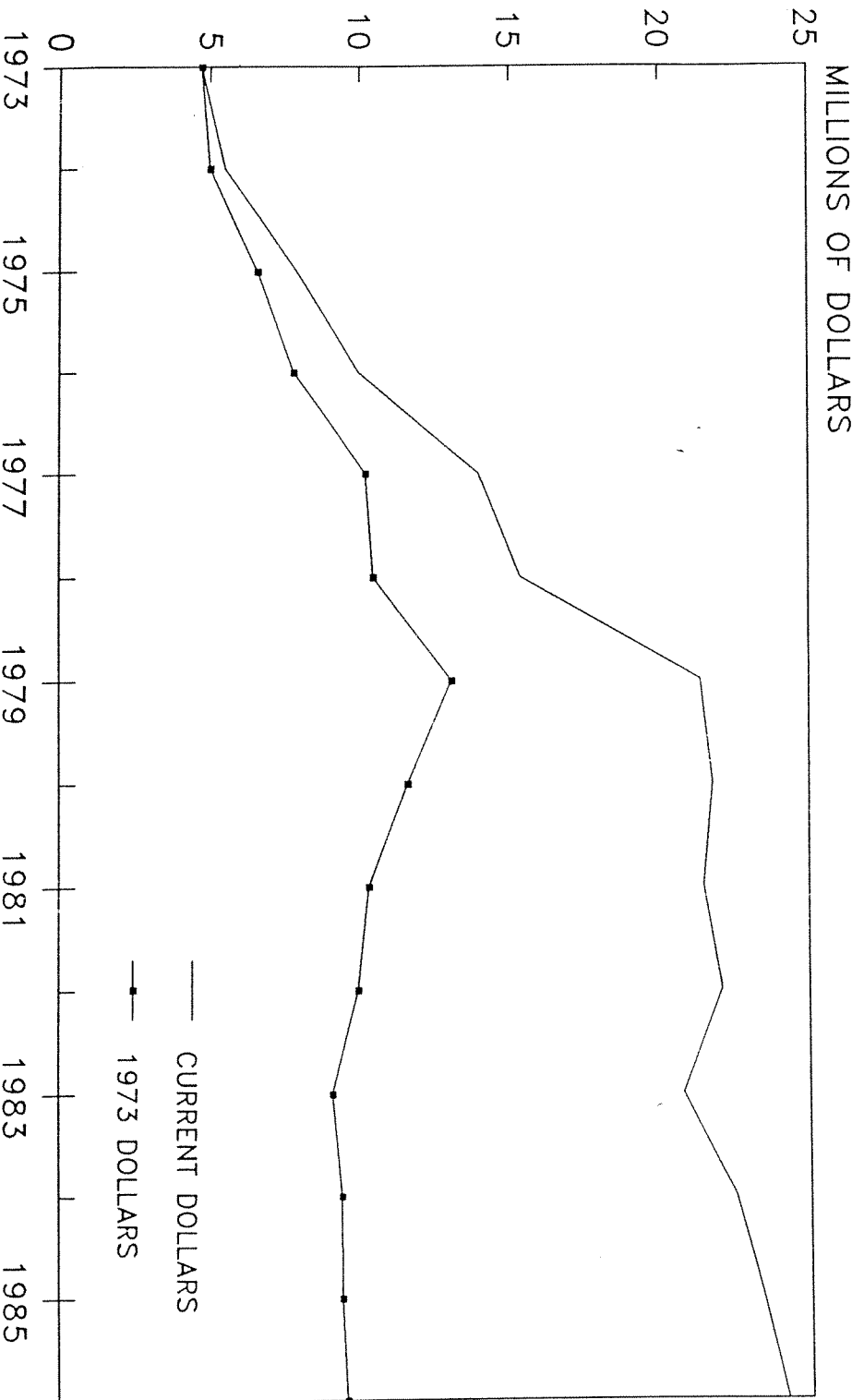

Source: Unpublished Wisconsin Dept.
of Revenue data

municipalities and the pulp and paper industry on the Lower Fox River. We can provide a summary of the above by examining the current (deflated) expenditure values. Deflating the time series of expenditures by changes in the consumer price index (CPI), the operating expenditures by municipalities in the Lower Fox River region totaled \$127.8 million (1973\$) over the 1973-1986 period. Given the previous estimates of the total operating expenditures by the pulp and paper industry and assuming these expenditures were evenly distributed over the 1976-1986 period, the real value of the sum of these expenditures was \$99 million.

In addition to the operating expenditures, we can deflate the series of capital expenditures. Over the 1973-1987 period, the deflated value of capital expenditures by municipalities on water pollution control totaled \$76.2 million (1973\$). This figure would more than double with the inclusion of the capital expenditures by the Green Bay Metropolitan Sewage District over the 1970-1973 period. Over the 1975-1987 period, the deflated value of capital expenditures by the pulp and paper industry was approximately \$39.6 million (1973\$).

IV. Review of RAP Rehabilitation Objectives for Southern Green Bay

In their review of the ecosystem approach to the analysis of Green Bay, Harris et al. (1987) note that the most critical stresses on the system are the presence of toxic substances, excessive levels of nutrients, high levels of total suspended solids and an unbalanced fishery. In order to assess the status of the Green Bay ecosystem, the authors present the following set of characteristics that should provide indicators of how the ecosystem is responding to rehabilitation efforts:

- (i) species composition and size distribution of phytoplankton and proportion of macrophytes to phytoplankton;
- (ii) zooplankton size distribution, grazing rates, consumptive capacity, and growth rates;
- (iii) species composition and size distribution of planktivorous fish and their growth rate and consumptive capacity;
- (iv) biomass, growth rate, reproductive rate, and toxic body burden of keystone predators (p. 621).¹¹

In the formulation of the remedial action plan for Southern Green Bay, specific management objectives were formulated. Before we discuss current estimates of the costs of further rehabilitating the lower portion of Green Bay we first present a review of the objectives set up for this region as stated in the Southern Green Bay Remedial Action Plan (WDNR, 1987d). In this discussion the relationship between these objectives and the above characteristics will be noted.

4.1 Overview of the Fishery Related Objectives

In Table 12 we present a listing of the objectives that deal directly with fisheries rehabilitation. The overall goal of fishery rehabilitation

¹¹Refer to Harris et al. (1987) Table 1, for a detailed listing of important characteristics of an ecosystem.

is the development of a balanced fish community. Increases in top predator species will result in a stable fish community. These activities will also complement actions undertaken to control the level of blue-green algae by reducing planktivore species (WNDR, 1987c p.28). In the first objective presented in Table 12, the goal is to reduce the concentration of contaminants in fish by the year 2000 so that all fish are placed in Group 1 within the Wisconsin Fish Consumption Advisory and have PCB concentrations of less than 2 ppm (see Table 9). Given the ecosystem approach to rehabilitation, this objective is complementary to improving the productivity of the sport and commercial fishery in that an increase in the top predators in the absence of the reduction in toxic substances would result in increasing numbers and species of fish with excessive levels of toxic substances.

As noted in the Biota and Habitat Management Technical Advisory Committee report, the unbalanced fish community in Southern Green Bay is characterized by low abundance and diversity of top predator and native forage species. The goal for the region is a cool water fish community characterized by percid and pike species. The desired community would have a predator-to-prey ratio of fish numbers ranging from 1/10 to 1/20. It is hypothesized that this would result in a more stable ecosystem with fewer dramatic fluctuations in species numbers and diversity.

The current (1985-1990) fishery management plan for the commercial yellow perch fishery in Green Bay calls for a sustained annual harvest of 600,000 pounds by 1991. The current (1987) commercial yellow perch quota for Green Bay is 400,000 pounds. In terms of the Green Bay yellow perch sport

Table 12. Fisheries Rehabilitation Objectives, Lower Green Bay and Fox River Area of Concern

Objective	Desired Population Density
Reduce Contaminants in Fish	
Improve Predator/Forage Fish Ratio	Biomass Range: 200 to 300 pounds per acre Predator-Prey Ratio Range: 1/10 to 1/20
Achieve Desired Yellow Perch Population	2,600 yearlings and older perch (at least 5 age classes) per trawl hour at index sites
Achieve Desired Walleye Population	7 Adults Per Acre
Reduce Carp Population	Minimum of 50% reduction as measured by reduction at index trawl stations
Achieve Desired Muskellunge Population	1 Adult Per 3 Acres
Achieve Desired Northern Pike Population	2 Adults Per Acre

Source: WDNR, 1987d

fishery, the current WDNR objective is to manage Green Bay for an annual sport harvest of 1.2-1.9 million yellow perch averaging 4-5 fish per pound. The WDNR is also trying to establish more age classes in the population (WDNR, 1986). A similar objective has been adopted for the rehabilitation plan for Southern Green Bay. The goal is to harvest at least 2600 fish per trawl hour with at least five age classes.¹²

Since 1973, over 1.7 million walleye fingerlings and 28 million fry have been stock in the Fox River, Sturgeon Bay and along the west shore of Green Bay. The current annual sport harvest of walleye in Green Bay has been estimated at 37,000. With a continued stocking program, the WDNR estimates

¹²The perch population in Green Bay is currently monitored by the WDNR trawling at specified sites. The level of 2600 fish/trawl hour is used as an index of perch abundance.

that a sustainable population of 150,000 walleye in Southern Green Bay could be maintained. Assuming an annual harvesting rate of 35 percent, an annual harvest of 50,000 walleye has been set as a management goal by the WDNR under its current management plan. In comparison, the goal stated in the Southern Green Bay RAP has been set at an annual harvest rate of 70,000 adults.

In 1985 the WDNR banned commercial carp fishing in Green Bay because these fish exceeded FDA standards for PCBs. It has been suggested that harvesting the carp population may be one way of removing PCBs from Green Bay and would also improve the overall fishery by removing an undesirable species. The TAC estimated that for every million pounds of carp harvested, 10 pounds of PCBs would be removed from the Bay's ecosystem. There is uncertainty with respect to the amount of carp present in the area of concern but a reduction of 50 percent of the current population has been established as one of the goals.

Northern pike is one of the top predators in the area. This species requires good quality wetlands for reproduction. Over the last decade the level of commercial catch has declined. Reasons for these losses include such factors as: (i) high water levels that restrict spawning habitat, (ii) possible overfishing, (iii) degraded spawning habitat, and (iv) natural population fluctuations (WDNR, 1987c p.30). The goal established by the RAP is for a northern pike fishery with 2 adults/acre.

In the past, the Great Lakes strain of muskellunge was present in Green Bay. Currently, the Great Lakes strain is present in Lake St. Clair which is similar to the environment present in Southern Green Bay. Using Lake St. Clair as a source of muskellunge eggs, a stocking program could be used to re-introduce the fish to Green Bay. The current objective is to increase

the population to 3,300 adults or 1 adult/3 acres.

4.2 Overview of Other Goals Associated with Rehabilitation

In addition the goals established directly dealing with the fishery other ecosystem rehabilitation goals have been established. Tables 13 and 14 present an overview of the goals associated with water quality, toxic substances, birds, wildlife, other aquatic life and habitat management. The reader is referred to the remedial action plan for a more detailed discussion (WDNR, 1987d).

Table 13: Water Quality and Toxic Substances Objectives, Lower Green Bay and Fox River Area of Concern

Objective	Parameter of Concern	Desired Concentration or Level
Water Quality		
Maintain Adequate Oxygen to Support Fish and Aquatic Life	Dissolved Oxygen	Minimum: 5 mg/L
Increase Water Clarity meters	Secchi Disk Depth	Average: .7 - 1.3
Reduce Algae Concentrations	Chlorophyll-a	Average: 35-45 ug/L
Reduce Total Phosphorus Concentrations	Total Phosphorus	Average: 100-125 ug/L
Reduce Bacteria Levels	Fecal Coliform	Should not exceed a log mean of 200/100 ml in 5 samples or exceed 400 per 100 ml in 10 percent of samples taken over a 30 day period.
Toxic Substances		
Reduce Toxic Substances in Fish and Wildlife	Total PCBs	Maximum: 2 mg/g
Reduce Swimming Impacts of Toxic Substances	---	---
Reduce Toxic Substances in Endangered Species	DDE Total PCBs	Maximum: 4 mg/g Maximum: 3 mg/g
Reduce Toxic Contaminants in fish used as feed	Total PCBs	Maximum: .1 ug/g
Reduce Toxics in Sediments	Total PCBs	Maximum: .05 ug/g

Source: WDNR, 1987d

Table 14. Wildlife and Habitat Management Objectives, Lower Green Bay and Fox River

Area of Concern	
Objective	Objective
Birds	Other Aquatic Life
Maintain Forster's tern population	Develop diverse community of Benthic organisms including: Hexagenia, Fingernail Clams, Snails, Mayflies and Caddis flies
Maintain common tern population	
Track cormorant population levels	
Support more dabbling ducks	Improve trophic dynamics
Support more diving ducks	Habitat
Protect marsh nesting birds	Eliminate discharge of toxics
Protect shorebirds	Maintain emergent wetlands
	Increase submergent vegetation
Wildlife	Protect shorebird habitat
Maintain muskrat population	Protect habitat for marsh-nesting birds
Maintain mink population	Protect other habitat for fish, aquatic life, wildlife, and endangered species

Source: WDNR, 1987d

V. Estimated Costs for the Rehabilitation of the Southern Green Bay Ecosystem

The Remedial Action Plan (RAP) for Southern Green Bay presented a list of 16 key actions. In a previous section we provided a brief overview of the objectives of the RAP both in terms of direct fishery related objectives as well as those indirectly influencing the Green Bay fishery. Table 15 presents the Key Actions used to achieve these goals along with the relative priority of each action. Tables 16 and 17 present cost estimates for adopting these key actions. The costs estimates are partitioned into those associated with capital purchase (Table 16) and annual operating and maintenance expenditures (Table 17). Table 18 presents a more detailed breakdown for each of the key actions.

5.1 Costs of Phosphorus Reduction

As shown by Tables 16-18, the objective of reducing phosphorus and toxic loadings are the most expensive key actions. The phosphorus reduction actions are dominated by the large capital costs associated with reducing non-point loadings. During 1982, it has been estimated that total phosphorus concentrations in Lower Green Bay ranged from 125 to 360 $\mu\text{g/L}$ with an average of 190 $\mu\text{g/L}$.¹³ Total phosphorus concentrations greater than 100 $\mu\text{g/L}$ result in hypereutrophic conditions (RAP p.38). The overall objective of the phosphorus related key actions is to reduce phosphorus concentrations in the range of 100-125 $\mu\text{g/L}$ and summer average chlorophyll-a

¹³Current non-point source control is obtained through a voluntary cost-sharing program, the Wisconsin Fund Non-point Source Abatement Program. Under administrative rule NR 104, municipalities with a population more than 2,500 are required to meet a 1 mg/L total phosphorus concentration limit or to provide an 85 percent phosphorus removal from discharged effluent from waste water treatment plants.

Table 15. Description of the Key Actions Considered in the Lower Green Bay
Remedial Action Plan

Action No.	Priority	Action Description
1	H	Reduce Phosphorus Inputs to the Fox River and Lower Green Bay From Point and Non-Point Sources
2	H	Reduce Sediment and Suspended Solids
3	H	Eliminate Toxicity of Industrial, Municipal and Other Point Source Discharges
4	H	Reduce Availability of Toxic Chemicals from Contaminated Sediments
5	H	Reduce Oxygen Demanding Wastes from Industrial and Municipal Dischargers
6	M	Protect Wetlands, and Manage Habitat and Wildlife
7	M	Reduce/Control Populations of Problem Fish
8	M	Increase Populations of Predator and Sport Fish
9	L	Reduce Sediment Resuspension
10	L	Reduce Bacteria Inputs From Point and Nonpoint Sources
11	L	Eliminate Toxicity Resulting from Nonpoint and Atmospheric Sources
12	H	Develop Institutional Structure for Plan Implementation
13	H	Increase Public Awareness and Participation in Restoration Efforts
14	M	Enhance Public and Private Shoreline Uses
15	---	Evaluate the Effectiveness of the RAP and Identify New Problems
16	---	Conduct Research with Respect to Understanding the Ecosystem of Lower Green Bay

Source: WDNR, 1987d

Note: H = high priority

M = moderate priority

L = low priority

Table 16. New Capital and Discrete Project Costs Associated with Green Bay Remedial Action Plan by Priority Level (\$1,000)

Action No.	High Priority		Medium Priority		Low Priority		Total	
	Low	High	Low	High	Low	High	Low	High
1	\$51,405	\$135,200	\$6,050	\$37,650	0	0	\$57,455	\$172,850
2	N/A	N/A	0	0	N/A	N/A	0	0
3	40	250	220	970	N/A	N/A	260	1,220
4	1,500	406,900	200	2,800	N/A	N/A	1,700	409,700
5	0	0	0	0	N/A	N/A	0	0
6	1,160	11,600	300	1,500	\$2,450	\$5,370	3,910	18,470
7	N/A	N/A	260	2,010	10	310	270	2,320
8	N/A	N/A	5	649	N/A	N/A	5	649
9	N/A	N/A	N/A	N/A	1,050	11,375	1,050	11,375
10	N/A	N/A	0	0	0	100	0	100
11	N/A	N/A	1,405	6,150	675	12,090	2,080	18,240
12	0	0	N/A	N/A	N/A	N/A	0	0
13	43	150	0	0	N/A	N/A	43	150
14	N/A	N/A	730	730	10	250	740	980
15	0	0	0	0	0	25	0	25
16	0	0	55	300	700	2,200	755	2,500
Total	\$54,148	\$554,100	\$9,225	\$52,759	\$4,895	\$31,720	\$68,268	\$638,579

Source: WDNR, 1987d

Note: For a description of the Action #'s refer to Table 3 and the Lower Green Bay Remedial Action Plan. N/A indicates that no parts of this action are included in this category.

Table 17. New Annual Operation, Maintenance and Program Management Costs Associated With the Green Bay Remedial Action Plan (\$1,000)

Action No.	High Priority		Medium Priority		Low Priority		Total	
	Low	High	Low	High	Low	High	Low	High
1	\$43	\$1,386	\$100	\$1,800	\$0	\$0	\$143	\$3,186
2	N/A	N/A	0	0	N/A	N/A	0	0
3	0	0	9	9	N/A	N/A	9	9
4	5	2,050	50	340	N/A	N/A	55	2,390
5	0	0	0	0	N/A	N/A	0	0
6	10	1,230	10	1,110	10	220	30	2,560
7	N/A	N/A	0	1,010	\$10	\$100	10	1,110
8	N/A	N/A	10	170	N/A	N/A	10	170
9	N/A	N/A	N/A	N/A	0	210	0	210
10	N/A	N/A	0	0	0	0	0	0
11	N/A	N/A	1	150	0	10	1	160
12	200	200	N/A	N/A	N/A	N/A	200	200
13	92	170	2	2	1	20	95	192
14	N/A	N/A	42	42	0	0	42	42
15	24	76	30	220	7	125	61	421
16	0	0	0	10	0	0	0	10
Total	\$374	\$5,112	\$254	\$4,863	\$28	\$685	\$656	\$10,660

Source: WDNR, 1987d

Note: For a description of the Action #'s refer to Table 3 and the Lower Green Bay Remedial Action Plan. N/A indicates that no parts of this action are included in this category.

Table 18. Detailed Distribution of New Costs Associate with The Remedial Action Plan for Lower Green Bay

Action No.	Description	Project Priority	Cost Ranges (\$1,000)				
			Capital		Annual		
			Low	High	Low	High	
1							
1.1	Evaluate Phos. Point Source Loads and Treatment Plant Capabilities	H	\$400	\$4,000	\$43	\$1,386	
1.2	Establish Phos. Water Quality Standards	H	0	0	0	0	
1.3	Establish Wasteload Allocation for Phos. if Necessary for Desired Reduction	H	5	100	0	0	
1.4	Initiate Intensive Watershed Management Projects to Reduce NPS Phos. Loads	H	51,000	131,050	0	0	
1.5	Identify Methods to Increase Participation in NPS Phos. Management	H	0	50	0	0	
1.6	Require Construction Run-off Control	M	0	0	100	200	
1.7	Require Shoreland Buffer and Green	M	6,050	22,600	0	0	
1.8	Adopt Animal Waste Management Laws Strips	M	0	0	0	100	
1.9	<u>In-River Phosphorus Removal</u>	M	0	15,050	0	1,500	
	<u>Sub-Total</u>		57,455	172,850	143	3,186	
2							
2.1	<u>Include Additional Land In Conservation Reserve Program</u>	M	TBD	TBD	TBD	TBD	
	<u>Sub-Total</u>		TBD	TBD	TBD	TBD	
3							
3.1	Complete Rule Adoption for Water Quality Standards	H	0	0	0	0	
3.2	Adopt Mixing Zone Rules For Lower G.B.	M	0	0	0	0	
3.3	Adopt Water Quality Standards for PCBs and other Bioaccumulating Substances	H	0	0	0	0	
3.4	Identify PCB Sources	M	170	470	0	0	
3.5	Monitor Fish Tissue	M	TBD	TBD	9	9	
3.6	Monitor and Control Discharges of PCBs and Other Bioaccumulating Substances	H	20	100	0	0	
3.7	Establish Water Quality Standards for Toxicants	H	TBD	TBD	TBD	TBD	
3.8	Evaluate and Control Amonia Toxicity	H	20	150	0	0	
3.9	Monitor and Control Discharges of Acute and Chronic Toxicity	H	0	0	0	0	
3.10	Identify Areas of Chronic Toxicity Problems	M	50	500	0	0	
3.11	Establish Standard Tests for Toxicity Monitoring	M	0	0	0	0	
3.12	Increase WDNR Capabilities for Monitoring Toxics	M	0	0	TBD	TBD	
3.13	<u>Use Additional Types of Toxicity Monitoring</u>	M	0	0	0	0	
	<u>Sub-Total</u>		260	1,220	9	9	

Table 18. (continued)

Action No.	Description	Project Priority	Cost Ranges (\$1,000)				
			Capital		Annual		
			Low	High	Low	High	
4							
4.1	Determine Amount of PCBs and Other Contaminants in the Fox River and Green Bay	H	600	900	0	0	
4.2	Conduct Remedial Investigation of In-Place Pollution Control Options	H	400	1,000	0	0	
4.3	Establish Federal, State and Local Programs to Remove In-Place Contaminated Sediments	H	0	0	0	0	
4.4	Clean-Up Contaminated Sediments	H	500	405,000	5	2,050	
4.5	Avoid Re-introduction of toxics to the Area of Concern	H	0	0	0	0	
4.6	Complete Adoption of New Administration Rules for Disposal of Dredged Materials	H	0	0	0	0	
4.7	Contain Existing Dredged Material to Avoid Re-introduction	M	100	2,000	50	340	
4.8	Coordinate Navigational Dredging Projects	M	0	0	0	0	
4.9	Develop 25 Year Dredge Disposal Plan and Evaluate Harbor Alternatives	M	100	500	0	0	
4.10	Minimize Impacts of Ultimate Disposal of Toxic Contaminants	M	0	300	0	0	
	<u>Sub-Total</u>		<u>1,700</u>	<u>409,700</u>	<u>55</u>	<u>2,390</u>	
5							
5.1	Remove Green Bay's Winter Dissolved Oxygen Water Quality Standard Variance	H	TBD	TBD	TBD	TBD	
5.2	Review and Revise Wasteload Allocations on the Lower Fox River	M	0	0	0	0	
	<u>Sub-Total</u>		<u>0</u>	<u>0</u>	<u>0</u>	<u>0</u>	
6							
6.1	Continue West Shore Land Acquisition	H	1,000	10,000	10	100	
6.2	Achieve Goals for Wetland and Other Habitat Protection	H	0	300	0	1,000	
6.3	Continue Enforcement of Wetland Zoning	H	0	0	0	0	
6.4	Consider Additional Wetland Zoning	M	0	50	0	0	
6.5	Encourage Private Wetland Preservation	M	0	50	0	1,000	
6.6	Change Bulkhead Lines to Protect Habitat	M	50	300	0	0	
6.7	Use Shore and Modification Permits to Protect Habitat and Water Quality	M	0	0	0	0	
6.8	Seasonally Limit Public Entry to Critical Habitat	L	0	10	0	10	
6.9	Use Habitat Enhancement Methods	M	250	1,050	10	110	
6.10	Consider Stabilizing Cat Island	L	1,000	1,050	0	10	
6.11	Dike Wetlands if Needed	L	1,000	1,250	0	10	
6.12	Improve Interstate-43 Wetland Mitigation	L	300	1,250	0	10	
6.13	Consider Development of Artificial Reefs	L	100	1,250	0	100	
6.14	Provide Upland Bird Nesting Habitat	L	0	250	10	50	
6.15	Undertake Purple Loosestrife in the AOC	L	0	10	0	100	

Table 18. (continued)

Action No.	Description	Project Priority	Cost Ranges (\$1,000)			
			Capital		Annual	
			Low	High	Low	High
6.16	Establish Breeding Sanctuaries and Management Programs for Endangered Tern Population	H	160	1,300	0	130
6.17	Protest Against Outbreaks of Avian Disease	L	0	0	0	0
6.18	Evaluate Mink and Muskrat Populations	L	0	50	0	10
6.19	Inventory Nongame Species on West Shore and Development Management Program	L	50	250	0	10
	<u>Sub-Total</u>		3,910	18,470	30	2,660
7						
7.1	Develop Program to Prevent Sea Lamprey Migration	M	10	1,000	0	10
7.2	Conduct Pilot Project to Evaluate and Manage Carp Population	M	250	1,010	0	1,000
7.3	Manage Alewife Population	L	0	60	10	100
7.4	Evaluate Potential for White Perch to Impact the Green Bay Fishery	L	10	250	0	0
	<u>Sub-Total</u>		270	2,320	10	1,100
8						
8.1	Expand Walleye Management Program	M	5	574	0	100
8.2	Continue Perch Management Programs	M	0	0	0	0
8.3	Initiate Program to Manage Northern Pike	M	0	150	10	60
8.4	Re-introduce Muskies to Lower Green Bay as Water Quality Improves	M	0	25	0	10
	<u>Sub-Total</u>		5	649	10	170
9						
9.1	Consider Pilot Projects to Control Suspended Sediments	L	0	75	0	10
9.2	Consider Spoil Bed Stabilization	L	1,050	10,250	0	100
9.3	Determine Causes and Manage Turbidity	L	0	1,050	0	100
	<u>Sub-Total</u>		1,050	11,375	0	210
10						
10.1	Recognize Use of Water As Swimming Resource	L	0	0	0	0
10.2	Disinfect MSTP discharges for Swimming and Other Resource Uses	M	0	0	0	0
10.3	Control Failing Septic Systems	L	0	50	0	0
10.4	Control Industrial Discharges	L	0	50	0	0
	<u>Sub-Total</u>		0	100	0	0
11						
11.1	Control Runoff of Toxic Substance from Watershed Sources	M	0	0	0	0
11.2	Control Urban Stormwater Discharges	M	115	700	0	0
11.3	Prevent Chemical and Coal Pile Runoff	L	100	5,000	1	50

Table 18. (continued)

Action No.	Description	Project Priority	Cost Ranges (\$1,000)			
			Capital		Annual	
			Low	High	Low	High
11.4	Initiate Industrial lot and Urban Runoff Control Demonstration Projects	L	50	1,000	0	0
11.5	Assess Impacts of Pesticides and Herbicide Use and Control as Necessary	L	10	50	0	0
11.6	Control Toxic Substances from Landfills	M	640	4,100	n/a	n/a
11.7	Evaluate Potential Groundwater Contamination	L	40	910	n/a	n/a
11.8	Investigate Sites of Past Coal Gas Manuf.	L	80	4,000	n/a	n/a
11.9	Monitor fuel Storage Tanks for Leaks	L	0	0	0	0
11.10	Evaluate and Minimize Impacts of Spills	L	0	50	0	10
11.11	Determine Atmospheric Deposition's Share to Toxic Substances Found in Green Bay	M	400	700	0	0
11.12	Identify Atmospheric Emission Sources	L	385	530	0	0
11.13	Enact Emission Controls that Consider Secondary Impacts on Water Quality and Human Health	M	250	650	0	0
11.14	Participate in National and International Strategies to reduce atmospheric deposition	L	0	0	0	0
	<u>Sub-Total</u>		2,080	18,240	0	160
12						
12.1	<u>Create Co-ordinating Council for RAP</u>	H	0	0	200	2,000
	<u>Sub-Total</u>		0	0	200	2,000
13						
13.1	Increase Opportunities for Public Partic.	H	18	50	17	45
13.2	Develop Public Information Programs	H	25	100	50	100
13.3	Develop Education Programs	H	0	0	25	25
13.4	Improve Accessibility of Water Quality Info.	L	0	0	1	20
13.5	Include Economic and Environmental Views in Policy Advisory Activities	M	0	0	0	0
13.6	<u>Form a Interest Group or Coalition</u>	M	0	0	2	2
	<u>Sub-Total</u>		43	150	95	192
14						
14.1	Upgrade Boat Launch Facilities	M	560	560	0	0
14.2	Encourage Environmental Sound Marina Devel.	M	0	0	7	7
14.3	Evaluate Potential for Beach Devel. in AOC	M	150	150	35	35
14.4	Develop Shoreline Fishing Facilities	L	10	250	0	0
14.5	Develop Recreational and Environmental Corridors	M	n/a	n/a	n/a	n/a
14.6	Revitalize Waterfronts and Enhance Shoreline	L	n/a	n/a	n/a	n/a
14.7	Develop management Plan for Renard Isle	M	20	20	0	0
14.8	<u>Improve Air Quality and Other Aesthetics</u>	M	n/a	n/a	n/a	n/a
	<u>Sub-Total</u>		740	980	42	42

Table 18. (continued)

Action No.	Description	Project Priority	Cost Ranges (\$1,000)			
			Capital		Annual	
			Low	High	Low	High
15						
15.1	Develop RAP Monitoring Program for Toxics	H	0	0	0	0
15.2	Increase Fish and Wildlife Tissue Monitoring	H	0	0	1	18
15.3	Periodically Monitor PCBs, Phos., sediment and Other Substances	M	0	0	10	100
15.4	Monitor Trophic Status	H	0	0	12	35
15.5	Increase Bacteria Monitoring	L	0	0	0	10
15.6	Monitor Waterfowl Population Trends	L	0	0	2	5
15.7	Monitor Endangered Tern Species Population	H	0	0	11	23
15.8	Monitor Fish Population Trends and Harvest	H	0	0	0	0
15.9	Monitor Benthic Organisms	M	0	0	10	20
15.10	Periodically Map Macrophytes	L	0	25	0	10
15.11	Measure Public Attitudes	M	0	0	5	50
15.12	Measure Use of Green Bay and Lower Fox R.	M	0	0	5	50
15.13	Collect Socioeconomic info. useful for <u>designing management options</u>	L	0	0	5	100
<u>Sub-Total</u>			0	25	61	421
16						
16.1	Complete Mass Balance Study of Toxics	H	0	0	0	0
16.2	Determine Causes of Walleye and Bird Reproductive Impairments	M	0	0	0	0
16.3	Conduct Epidemiology Study	M	50	200	0	10
16.4	Study Benthic Populations	M	5	100	0	0
16.5	Evaluate Trophic Dynamics	L	100	200	0	0
16.6	Complete Comprehensive Studies of Fish Populations in the AOC	H	0	0	0	0
16.7	Determine Potential for "Top Down Manage- ment" in the AOC	L	500	1,000	0	0
16.8	Improve Capability to Analyze Water Resource Alternatives	L	100	1,000	0	0
16.9	Develop New Technologies to Clean Up, Control or mitigate Toxic Contaminants in <u>Sediments</u>	H	0	0	0	0
<u>Sub-Total</u>			755	2,500	0	10
<u>All Actions Total</u>			68,268	638,579	656	10,760

Source: WDNR, 1987d

Note: A value of 0 was assigned if (1) no applicable costs were associated with this action, (2) the costs were part of ongoing cost or costs included in another recommendation, or (3) costs associated with an action are part of a national or statewide program not specific to the RAP.

AOC represents "area of concern" and refers to Southern Green Bay and the Lower Fox River

L refers to Low priority

M refers to Medium priority

H refers to High priority

concentration of 35-45 $\mu\text{g/L}$. The Remedial Action Plan suggests that a wasteload allocation system for phosphorus loadings be established in order to obtain these standards. In Table 19, alternative point and non-point phosphorus allocation alternatives are presented. Under each alternative the point source controls and the number of watersheds in the program are varied so as to obtain the above phosphorus and chlorophyll-a concentration goals. Figure 1 displayed the Fox-Wolf River drainage basin along with the area composed of the 11 watersheds that were identified as primary areas for non-point phosphorus loading control. These 11 watersheds are believed to be the source of the greatest non-point loadings of phosphorus and sediment to Green Bay.

The Nutrient and Eutrophication Technical Advisory Committee estimates that the total capital costs for non-point source controls range from \$51-80 million dollars depending on the number of watershed projects involved which in turn depends on the level of point source control. Under the least stringent point source controls (.5 mg/L of effluent), the total costs of intensive non-point source watershed projects were estimated to be:

\$27.1 million for 5 watersheds on Lower Fox River
23.7 million for 6 watersheds on Lake Winnebago
80.0 million for 30 other watersheds in Fox-Wolf Basin

The type of non-point source control projects that may be implemented under the phosphorus control program are listed in Table 20. In addition, a rating of each program is presented. Since the agricultural sector is a major source of non-point phosphorus loadings in the Lower Fox River region, a majority of the non-point control recommendations focus on control of agricultural runoff and soil erosion.

The most highly rated alternative for controlling non-point nutrient loadings is the establishment of riparian zoning to protect buffer strips

Table 19. Alternative Phosphorus Effluent Standards for Meeting Desired Phosphorus Objectives

Alternative	Source Control Level		
	Municipal (mg/l)	Industrial (mg/l)	Nonpoint (no. of watersheds)
1	.1	.1	11
2	.3	.3	21
3	.5	.5	41

Source: WDNR, 1987d p. VI.18

Note: The municipal controls are for communities with over 2,500 population. It is assumed that a 40 percent reduction in non-point watershed loadings of phosphorus is to be achieved under each alternative for those watersheds included.

along waterways. As noted in the Nutrient and Eutrophication Management Technical Advisory Committee report (WDNR, 1987a), these non-point sources can have direct and measurable impacts on water quality. Many of the streams and rivers in the Fox River basin lack vegetative cover along the stream banks which results in little buffering between the stream and the non-point sources of phosphorus such as livestock, agricultural based soil erosion, and urban run-off. A 33 foot wide buffer strip was estimated by the TAC to remove 25 percent of the phosphorus from surface runoff in the watersheds. A 50 foot-wide buffer strip was estimated to remove up to 50 percent of the sediment loadings. The recommended buffer strip would depend on adjacent land use, soil type, amount of runoff, soil slope and vegetative cover.

Consistent with the ecosystem approach, the use of buffer strips have additional benefits such as improved fish and wildlife habitat, private recreational uses and stream aesthetics. Alternatively, from the landowner's perspective, the use of riparian zoning would require a change in the statutory law to lands not currently covered by shoreland/wetland

Table 20. Non-Point Source Phosphorus Control Alternatives

Alternative Rating	Effectiveness	Time Frame (years)	Est. Cost (1000 \$)	Non-Point Source Phosphorus Control Project Description
3.3	< 3%	1-5	< 250	Adopt manure management ordinances in all counties to manage manure spreading
3.0	< 3%	10-15	1,000-10,000	Provide cost-sharing incentives for animal waste management downstream of Lake Winnebago
3.3	< 3%	5-10	1,000-10,000	Regulate animal waste more stringently than NR243
3.0	< 3%	ongoing	1,000-10,000	Counties should consider water quality objectives for Green Bay when implementing county soil erosion plans
3.8	< 3%	1-5	< 250	Develop information/education programs with respect to the RAP.
3.3	< 3%	1-5	< 250	Examine best tillage practices to reduce soil loss and phosphorus loadings and make recommendations for best practices for farms
3.3	< 3%	1-5	< 250	Improve application of fertilizers and conduct soil tests.
3.0	< 3%	ongoing	< 250	Use education programs for proper application of fertilizers.
3.0	3-10%	ongoing	?	State and counties should maintain land conservation programs as federal dollars are phased out.
3.7	>10%	1-5	< 250	Create political support for water quality/nonpoint source programs that exist.
4.5	3-10%	10-15	> 10,000	Institute riparian zoning to protect a buffer strip along waterways from non-point source land uses.
3.6	?	1-5	1,000-10,000	Raise funds for non-point source cost sharing
3.3	?	1-5	250-10,000	Implement a county-based tax credit program similar to farmland preservation
3.7	>10%	ongoing	> 10,000	Gain federal funding or create special federally funded projects to implement RAP throughout the Great Lakes
3.7	current policy			Ensure cross-compliance at state level by requiring compliance with non-point source objectives or best management objectives to be eligible for agricultural support

Source: WDNR, 1987a.

Note: To determine the alternative rating each TAC member individually rated the management alternative on the basis of how well each alternative contributed to achieving the RAP objectives. The following rating system was used:

Excellent: 4.5-5
 Very Good: 3.5-4.4
 Good: 2.5-3.4
 Very Poor: .5-1.4

Effectiveness was measured by how much each alternative would reduce the entire phosphorus load to the AOC.

zoning (including agricultural land which is currently exempt from zoning). The use of zoning requiring buffer strips prohibits the use of the land for other economic activities. As such, if the riparian zoning is used, programs of tax credits, cost sharing or easement purchases may need to be implemented.

In estimating the costs of establishing riparian zoning for buffer strip development (>\$10 million), the TAC assumed an easement purchase program. They estimate that for the typical watershed in the region, purchase of buffer areas would cost approximately \$500,000. This estimate is based on the assumption that there are 150 miles of streams in each watershed where 1/3 of the streams are required to have buffer areas of 60 feet. Costs estimates ranged from slightly more than \$6 million for a program encompassing 11 watersheds to over \$22.5 million for the entire basin (41 watersheds).¹⁴

5.2 Estimated Costs of Reducing Toxic Contaminants in Southern Green Bay

Key Action 4 as outlined in Table 15 was designed to reduce the level of toxic substances found in Green Bay. Primary concern was in terms of reducing the level of PCBs in both current point sources as well as the resuspension from sedimentary sources. This action is important for the rehabilitation of both commercial and sport fisheries given recent experiences with fish consumption advisories and the closing in 1984 of the commercial carp fishery due to excessive PCB concentrations.

¹⁴The recommendations of the RAP for controlling nonpoint sources of phosphorus loadings could take 10-15 years to be fully effective. Given the number of watersheds affecting the region, 3 projects would have to be implemented over each of the next 4 years to complete 11 projects by the year 2000 or 5 projects a year to complete 21 projects by the end of the century.

The major cost associated with Key Action 4 could come from a full scale project of cleaning contaminated sediment in the Lower Fox River and Southern Green Bay. The objectives of these activities would be to (i) minimize the possibility of resuspension and downstream transportation of contaminated sediment during dredging and (ii) clean up sediments until the active sediment zone is less than or equal to $.05 \mu\text{g/g}$ dry weight total PCBs and (iii) attain the International Joint Commission target of concentration of $.1 \mu\text{g/g}$ for fish and aquatic life. The costs of such an activity would depend on such factors as: the amount of material handled, the level of contamination found in the sediment, and disposal costs (WDNR, 1987d p. VI.50). The Toxic Substances Technical Advisory Committee estimates that the costs of dredging and disposal of contaminated sediment would be \$20-\$50/yd³ of sediment removed.

5.3 Costs of Fisheries Rehabilitation

5.3.1 Costs Associated with Fisheries Rehabilitation-Exotic Species

The Green Bay RAP calls for a limited amount of new expenditures directly concerned with fisheries rehabilitation as related to exotic species. None of the fishery related actions were classified as having a high priority (Table 15). In terms of moderate priority projects, the development of programs to manage the sea lamprey and carp have the highest expected capital costs. Sea lamprey are currently not a problem in the region. Should water quality in the Lower Fox River and Southern Green Bay improve, there is some concern that sea lamprey may move into the AOC and subsequently into Lake Winnebago and the Wolf River. The management alternative suggested to prevent such a migration is the closure of one of the locks on the Fox River. Cost of the closure would range from \$10,000 to

\$1 million.

In terms of the management of the carp population, the RAP recommends a 3-year pilot project to examine the ecosystem impacts of large scale carp removal. This project would include determining: (i) the role of carp in the ecosystem, (ii) the potential for removing toxicants from the river and bay, (iii) the economic impacts of an improved fishery, (iv) the market potential for the sale of fish meal or other by-products, and (v) an evaluation of "ultimate" disposal options for carp and/or toxic substances extracted from them (WDNR, 1987, p. VI.80). As noted in the RAP, the 3-year pilot project is estimated to be in the range of \$250,000 to \$1 million. Ongoing annual management costs was estimated to range from zero under a no management scenario to over \$1 million.

The RAP presents two lower priority objectives concerned with the management of the alewife population and in determining the potential impacts of white perch on the yellow perch fishery. The RAP advocates continued research activity in order to better understand alewife and perch interactions. If alewife control is determined to be desirable, alternative methods of control should be investigated including spring harvesting or the stocking of top predators. As shown in Table 19, annual costs were estimated to be quite low: less than \$100,000.

5.3.2 Costs of Fisheries Rehabilitation-Native Species

As shown in early discussion, the WDNR has had a walleye stocking program since the late 1970's. Recommended Action 8.1 has as its primary goal the establishment of a self-sustaining walleye population. The actions recommended for obtaining this self-sustaining population include:

- (i). Complete a study to identify potential spawning areas and identify improvement and protection needs;
- (ii). Continue to monitor and evaluate walleye reproductive success and

population numbers, making changes in the walleye stocking and management program as necessary;

- (iii). Continue to monitor walleye for contaminants and issue appropriate consumption advisories;
- (iv). Assess management options for reducing exposure of public to contaminants in fish;
- (v). Conduct research to determine possible cause and effect relationships for walleye reproductive impairments; and
- (vi). Protect and improve walleye spawning areas as indicated by (i) (WDNR, 1987d, p. VI.85)

There are current WDNR fish management projects that are evaluating walleye spawning areas and populations. Costs of reducing human exposure to contaminants was estimated to be less than \$10,000. Costs of protecting and developing new spawning areas are estimated to range from zero to \$250,000 with annual maintenance costs of zero to \$100,000.

In terms of yellow perch management (Action 8.2) the current WDNR goals are to establish more age groups in the yellow perch fishery. Up until recently, the fishery was limited to 1 or 2 age classes. A desired number of age classes would be 4 or 5. Some progress is already being made toward achieving the goal. The older and larger fish would not only enhance the recreational fishery and promote stability of both recreational and commercial catches, but might improve water clarity by feeding on benthic organisms rather than zooplankton. In terms of yellow perch management, the RAP does not envision any new capital or annual costs of managing the yellow perch fishery. The ongoing fish management program currently encompasses the actions recommended by the RAP.

The remedial action plan provides recommendations with respect to two other native species: northern pike and muskellunge. With respect to northern pike, the RAP recommends that a study be implemented to study northern pike populations in the region in order to identify those factors

which may be limiting the northern pike population. The report also advocates determining the potential for new spawning areas and to protect and improve current areas if necessary. They also advocate the stocking of northern pike to establish a self-sustaining local population in areas where they are not currently located. The RAP estimates that studying the factors that currently limit northern pike populations are expected to cost less than \$50,000. The stocking of northern pike is expected to have an annual cost of \$10,000-\$50,000. Costs of protection and improvement of spawning areas are also projected to be relatively low with an initial cost of less than \$50,000 and annual maintenance costs of less than \$10,000 (WDNR, 1987d, p.VI.88).

In terms of efforts to re-introduce muskellunge to lower Green Bay (Action 8.4) as water quality improves, the RAP suggests that an evaluation be conducted to determining the feasibility of stocking muskellunge eggs obtained from Lake St. Clair. Evaluation of the feasibility of stocking are projected to be less than \$25,000, with annual stocking costs of less than \$10,000.

From Table 18 we see that the total direct capital costs of fishery rehabilitation efforts (Actions 7 and 8) if all projects were adopted would range from \$275,000 to \$2.969 million. The total direct annual costs were estimated to be in the range of \$20,000 to \$1.270 million. The major cost component would involve efforts to manage the carp population.

5.4 Total Capital and Operating Costs

Examining the last rows of Tables 16 to 18, current estimates of the total costs of rehabilitating lower Green Bay are presented. These estimates are subject to large amounts of uncertainty. This uncertainty is

due to several factors including the geographic area involved with rehabilitation activities and the undertaking of activities that have not had a history in terms of rehabilitation efforts. In terms of one-time capital costs, the estimated range is from \$68.3 million to over \$638.6 million if all proposed projects are undertaken. High priority projects were estimated to have capital costs in the range of \$54.1 to \$554.1 million dollars. If all projects are undertaken, the annual operating and maintenance costs were estimated to be in the range of \$646,000 to \$10.3 million. High priority projects were estimated to have annual costs in the range of \$374,000 to \$5.1 million.

VI. Review of the Status of Fisheries and Water Quality in the Bay of Quinte

As noted in Chapter I, large areas of the Bay of Quinte are in an advanced state of eutrophication. This condition has been evident since the mid-1940's. Hurley and Christie (1977) note that low levels of dissolved oxygen and high levels of phytoplankton were the initial noticeable impacts of the increased nutrient loadings. Since the 1950's, turbidity has increased while, at the same time, increased algal growth has had negative impacts on commercial fishing and obstructed the water intakes of municipal treatment plants. This section of the report will provide an overview of the current status of the Bay of Quinte in terms of water quality and the commercial and sport fisheries.¹⁵ Throughout this discussion we will attempt to relate changes in the bay's ecosystem with changes in the level of eutrophication. In terms of examining the changes in the bay's ecosystem, it is useful to partition the Bay of Quinte into three sections. Referring to Figure 2, in Chapter I, we can define the Upper Bay as extending from the Trent River to Deseronto. The Middle Bay is defined as that portion of the bay between Deseronto and Glenora including Long Beach, Hay Bay and the area between Picton to Glenora. The Lower Bay extends from Glenora to Adolphus Reach. General characteristics of the three regions are presented in Table 21. Given this partitioning of the bay:

"The Upper Bay because of its shallowness, has always been more eutrophic than the deeper, Lower Bay. The fact that the major population centers are located on the Upper Bay has accentuated this difference. The result has been a greater development in the Upper than in the Lower Bay of several of the classic sign of eutrophication: increased algal density,

¹⁵For a more complete discussion of the impacts of phosphorous controls on the quality of the water resources in the Bay of Quinte the reader should refer to the Project Quinte report published by the Canadian Journal of Fisheries and Aquatic Sciences, Minns et.al.(1986).

decreased water transparency and species shifts among most taxa" (Hurley and Christie, 1977 p.1851).

Table 21. Characteristics of Three Regions of the Bay of Quinte

Characteristic	Unit	Bay of Quinte	Upper Bay	Middle Bay	Lower Bay
Area	km ²	257.4	136.4	49.2	71.8
Volume	10 ⁶ m ³	2487.7	476.5	255.4	1755.8
Length	km	86	48	16	22
Width	km	.6 - 5.6	.6 - 4.5	.8 - 5.6	3
Mean Depth	m	9.1	3.2	6.3	23.8
Flushing Rate					
Annual		2.6	11.7	23.5	3.8
Summer		.6	2.7	5.5	.9

Source: Hurley and Christie (1977) and Minns et al. (1986).

Note: The flushing rates represent the number of times during the time period of concern that the volume of water contained in the Bay flows through the Bay. The flushing rate estimates are average rates observed over 1965-1981.

There are four major rivers that enter the Upper Bay. This large watershed contributes to a high and variable flushing rate and relatively large amounts of non-point phosphorus loadings into the bay. Waste treatment plants contribute phosphorus mainly in the Upper Bay. No major rivers or point sources are present in the Lower Bay. The Middle Bay acts as a zone of periodic mixing of Upper and Lower Bay water (Johnson, 1986). Table 22 provides a description of the land use patterns in the major drainage areas which affect water quality in the bay. From this table we see that over a third of the land is devoted to agriculture and only 1 percent is devoted to urban uses. We also see that over two-thirds of the drainage basin area is associated with the Trent River.

6.1 Description of the Commercial and Sport Fisheries of the Bay of Quinte

The Bay of Quinte supports many varieties of fish, most being warm or

Table 22. Drainage Areas, River Flows, and Land Use Characteristics, Bay of Quinte

Location	Drainage	Area (km ²)	Land Use Characteristics				Flow (m ³ /s)
			Urban	Agriculture	Forest	Marsh/Swamp	
Upper Bay							
	Trent R.	12549	.9	36.1	59.7	1.9	149.3
	Moira R.	2737	.6	26.6	69.4	2.9	31.7
	Salmon R.	898	.4	31.9	62.7	3.7	11.2
	Napanee R.	787	1.1	40.5	56.2	2.0	9.7
	Misc. Rivers	708	3.3	72.5	20.7	3.3	----
Middle Bay							
	Wilton Cr.	127	.3	74.5	23.3	2.0	1.5
	Misc. Rivers	265	8.7	64.7	25.8	---	----
Lower Bay							
	Misc. Rivers	85	---	77.8	19.6	.7	----
Total							
		18182	1.0	37.1	58.7	3.3	----

Source: Minns et al.(1986) Table 1, p.62.

Note: The flow estimates are mean values over the 1965-1974 period as reported in Minns and Johnson (1979).

cool water species found in nearshore zones. Cold water species such as alewives, lake whitefish, lake herring, and several types of salmonids also live in the bay at certain times of the year. As noted in Hurley (1986), the major effect of eutrophication on the fish population is in terms of the abundance of food organisms in that, "Algal density, increased by nutrient inputs, affects water clarity, zooplankton composition and biomass, macrophyte abundance and, through biochemical degradation, oxygen concentrations near the bottom and thereby [the] composition of the benthic community." (p.211). This section of the report discusses the characteristics of the commercial and sport fisheries present in the Bay of Quinte and recent changes in these fisheries.

6.1.1 An Overview of Commercial Production in the Bay of Quinte

The level of commercial production in the Bay of Quinte has remained relative constant since 1950 at approximately 1 million pounds (Figure 25). For both Lake Ontario and the Bay of Quinte fisheries, maximum harvests occurred in the early 1900's with 5.25 and 1.75 million pounds, respectively. The bay accounted for less than 22 percent of Lake Ontario production in 1904. In comparison, in 1965, the region accounted for 50 percent of total production. On average, the commercial harvests in the bay were 35 percent of total Lake Ontario harvest (by weight).

In spite of the relatively stable overall production in recent decades, the composition of the species harvested has changed considerably over the last fifty years. Prior to the 1940's, the major commercial species harvested were lake herring and whitefish. By the 1950's the role of these species was reduced and replaced by increased carp, catfish and bullhead (*Ictalurus* spp.), and walleye harvests. By the late 1950's, the level of lake herring and whitefish harvests were close to zero. In Figure 26, we see that in the 1960's and 1970's yellow and white perch catches increased dramatically.

In terms of the trends of the harvest of individual species, Figure 27 shows the level of northern pike and walleye production since the early 1900's. After 1920, the level of commercial harvest of northern pike has declined from a maximum of 140,000 pounds to less than 10,000 pounds in the late 1960's. Historically, the other primary piscivore in the region was the walleye. From Figure 27, we see that the commercial walleye harvest experienced a dramatic decline in the early part of the century, increased during the late 1940's and into the 1950's and declined again during the

FIGURE 25
TOTAL COMMERCIAL HARVEST - BAY OF QUINTE

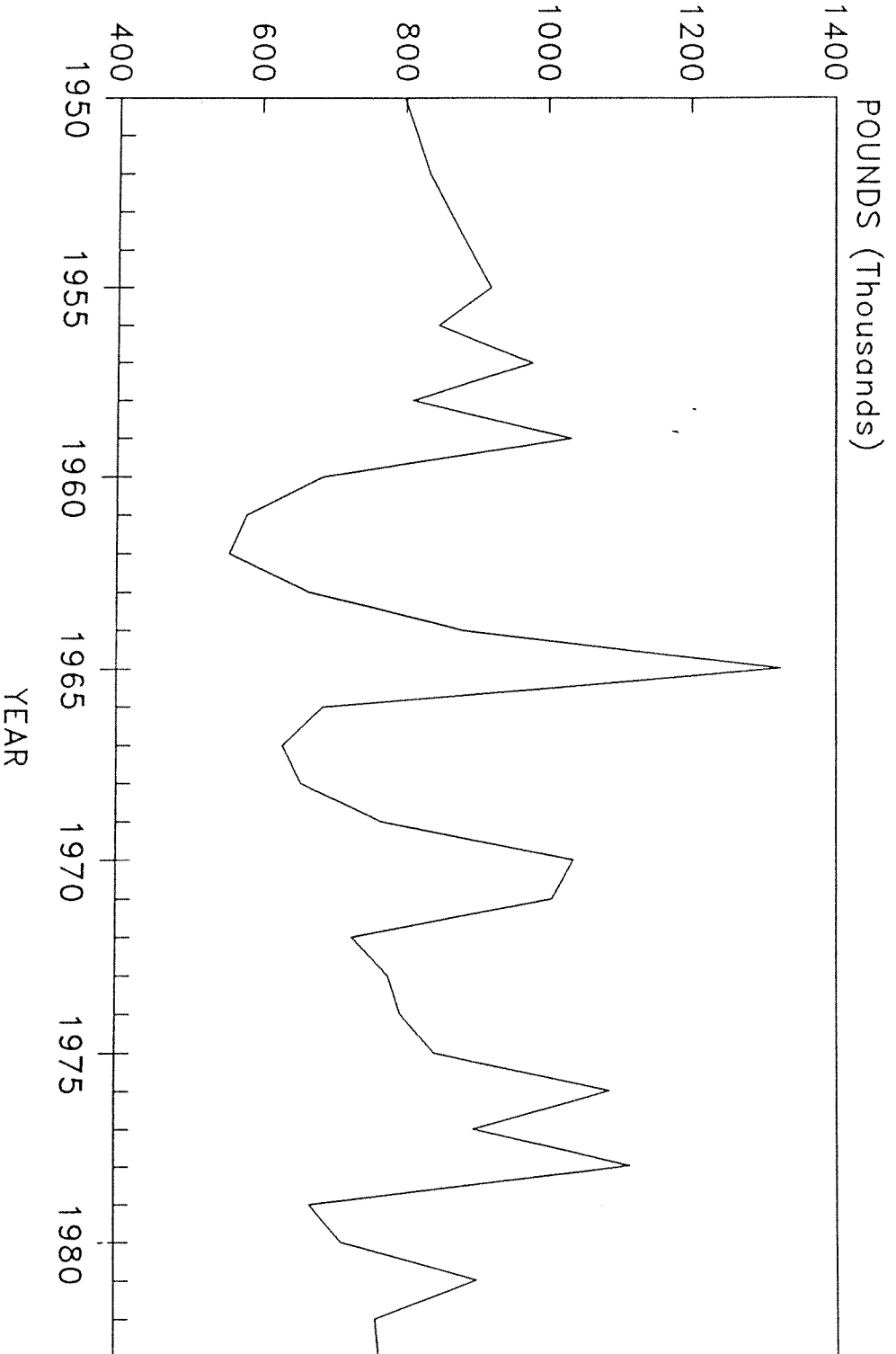

Source: Baldwin et al. (1979), Christie et al. (1973) and Ontario Ministry of Natural Resources (various issues)

FIGURE 26
 MAJOR COMMERCIAL SPECIES HARVESTED
 BAY OF QUINTE

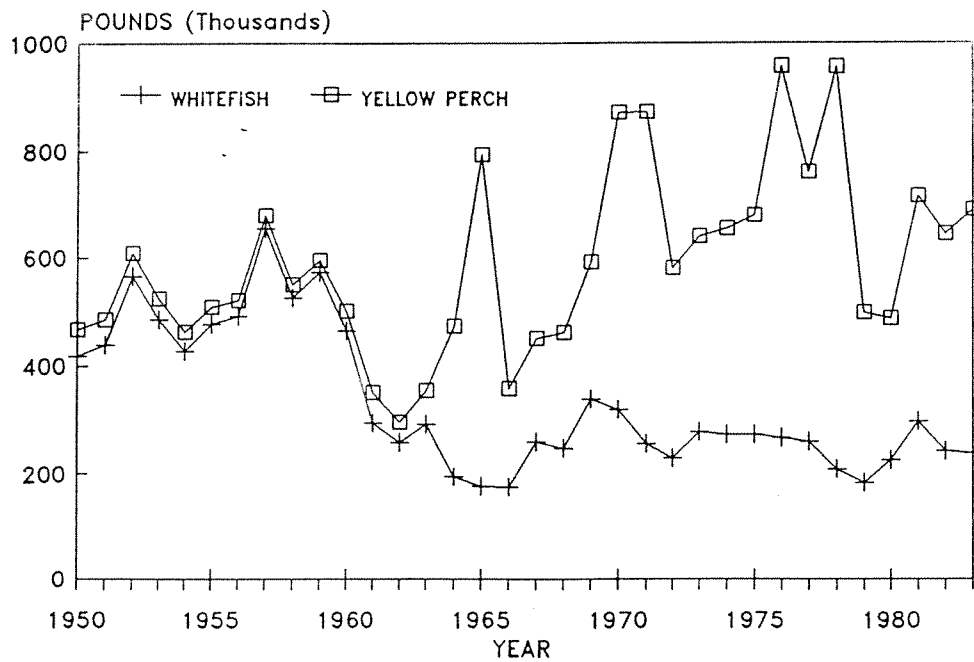
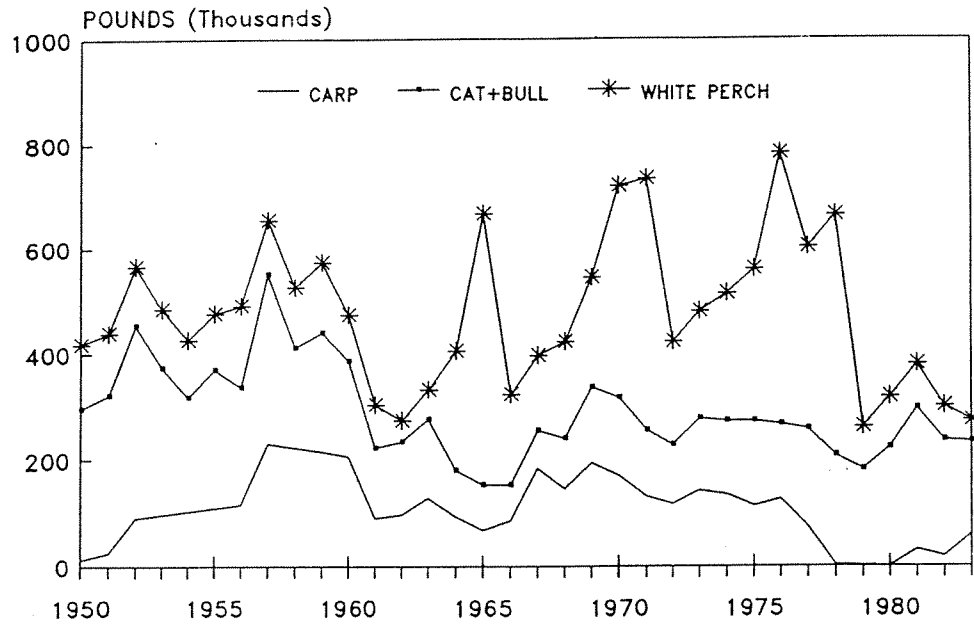

Source: Baldwin et al. (1979), Christie et al. (1973) and Ontario Ministry of Natural Resources (various issues)

FIGURE 27
COMMERCIAL HARVEST OF NORTHERN PIKE AND
WALLEYE—BAY OF QUINTE

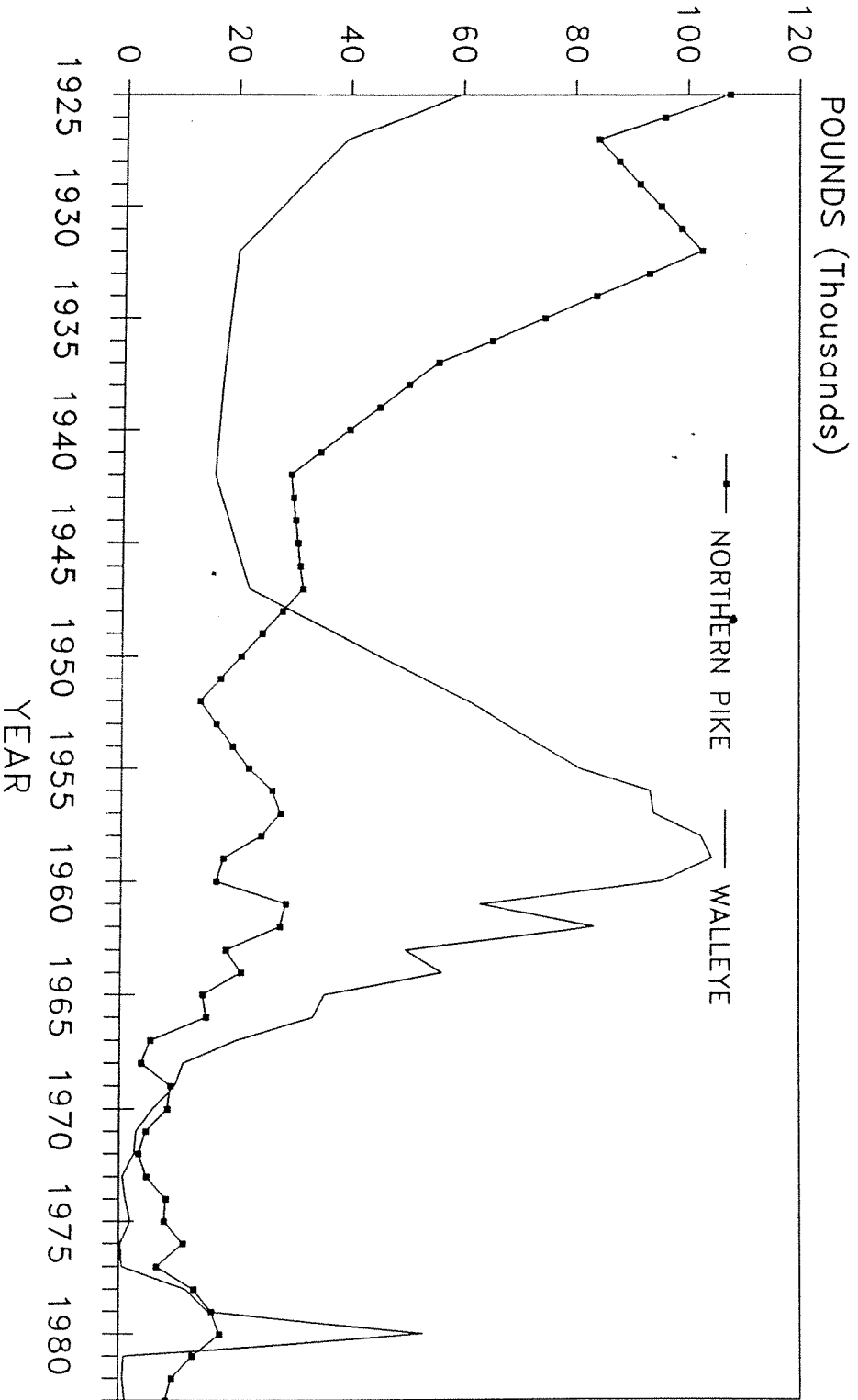

Source: Baldwin et al. (1979), Christie et al. (1973) and Ontario Ministry of Natural Resources (various issues)

early 1960's and 1970's.

As noted earlier, during the early 1900's, lake whitefish and herring were the primary commercial species (Figure 28). There has been much speculation as to the reason for the collapse of the lake herring fishery. Christie (1973) hypothesizes that one of the reasons for the collapse was increase predation by and competition from rainbow smelts. In terms of reduction in the lake whitefish catch, the author also notes that increased fishing effort may have been one of the major factors accounting for the decline.

After reduced lake trout and lake herring stocks, the commercial fishing industry turned its attention to the whitefish. With the introduction of nylon gillnets in 1950, commercial fishing was able to be continued at levels of stock density that previously would have precluded commercial exploitation. This resulted in a 300 percent increase in fishing effort (Christie, 1973 p.19). In the late 1950's harvesting rates of over 50 percent were recorded with an associated reduction in average age of fish caught. In addition to overexploitation, an increased presence of the sea lamprey may have negatively affected whitefish stocks due to the reduced lake trout and burbot populations.

The trends displayed in Figure 28 show more than a decade between the collapse of the lake herring and lake whitefish fisheries. Christie (1973) found this surprising given the these two fish species spawned in the same areas and the fry intermingle freely. The author explains this time lag:

"Levels of algal density sufficient to cause gillnet fouling, and thus perhaps sufficient to endanger fish eggs incubating on the bottom through the winter did not develop until the 1950's....The ascendancy of the smelt coincided with the loss of the lake herring and predation on the herring eggs and fry by smelt may well have been important. The most tenable explanation for the persistence of the whitefish after this event

FIGURE 28
COMMERCIAL HARVEST OF LAKE HERRING
AND WHITEFISH—BAY OF QUINTE

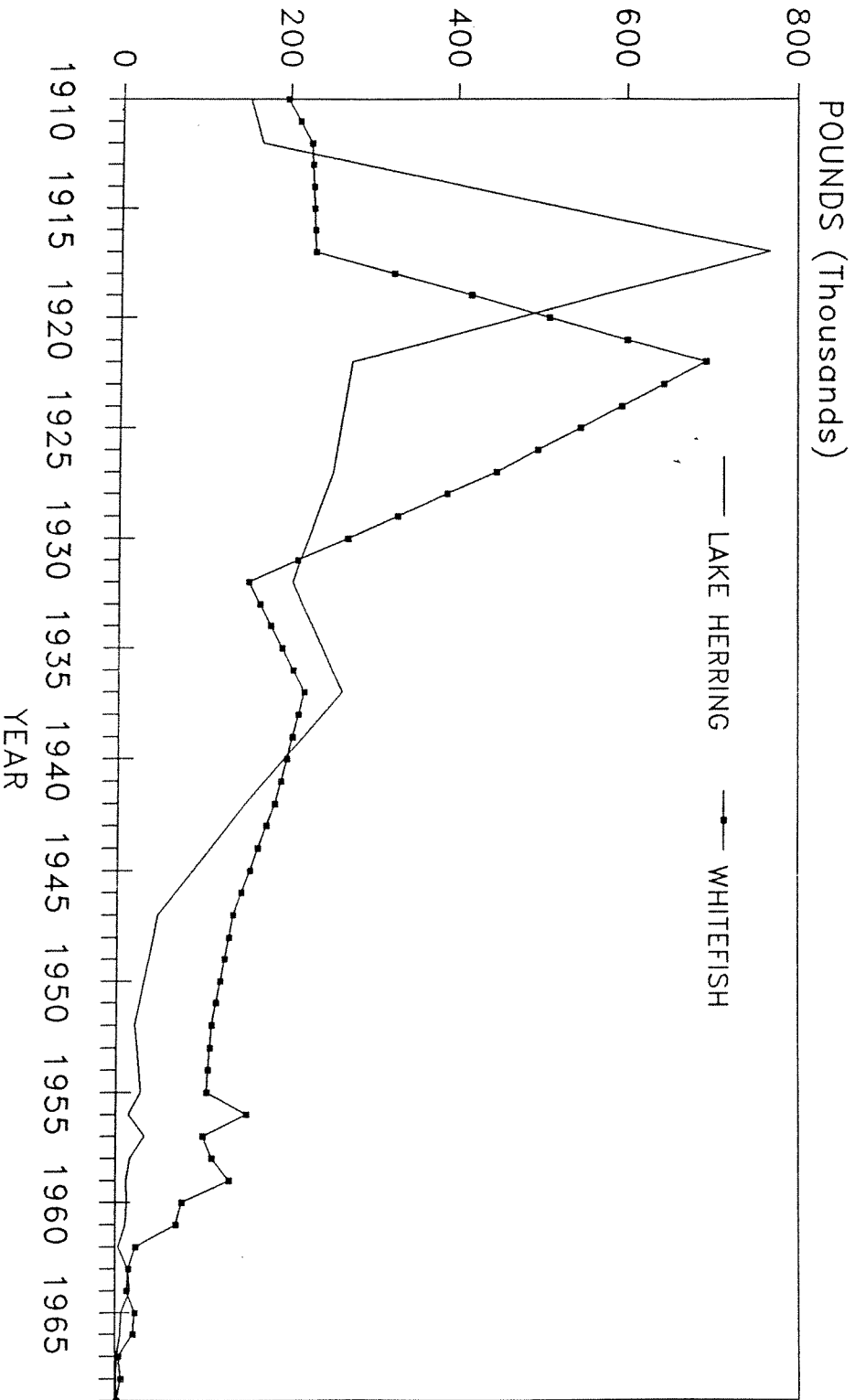

Source: Baldwin et al. (1979), Christie et al. (1973) and Ontario Ministry of Natural Resources (various issues)

appears to be that they were still abundant enough in the mid-1940's, to absorb a further increase in juvenile mortality, whereas the herring were not. The numbers of whitefish in turn, were severely reduced during the 1950's, and the explosion of the white perch population may have been the factor which triggered their collapse after the critical population level was reached" (p.22).

Scott and Christie (1963) hypothesize that the first white perch entered Lake Ontario around 1950 with large numbers having been taken in test netting since 1955. White perch were first captured commercially over the winter of 1964-65. Over the 15 year period, 1964-1979, white perch harvest averaged more than 250,000 pounds (Figure 29). Again, the major reason for the dramatic increase in white perch catch rates may be primarily due to the scarcity of all major predators except walleyes (Christie, 1973 p.41).

Minns and Hurley (1986) present data with respect to the level and type of effort applied to the harvest of white perch. Figure 30 shows that in contrast to the rather erratic level of commercial harvest over the 1960-1981 period, the level of effort exhibited a general upward trend from close to zero in 1960 to over 2 million yards/year of gillnet lifted. Besides the general increase in effort, the composition of that effort in terms of gillnet mesh size has changed dramatically. During the initial period of harvest, 60 percent of the gill net used was of the large size (4.25 inches) and the remaining was small-mesh (2.25-3 inches) (Figure 31). Since then the use of large-mesh gillnets have dropped to close to zero with over 85 percent being small gillnets in 1981.

Prior to the late 1950's, the level of yellow perch harvest was relatively stable at 50,000-100,000 pounds. During this early period the principle determinant of the level of catch were marketability and the availability of higher priced fish (Christie, 1973). After the early 1960's there has been a dramatic increase in the commercial harvest of yellow

FIGURE 29
YELLOW PERCH AND WHITE PERCH
AS A PERCENT OF BAY OF QUINTE HARVEST

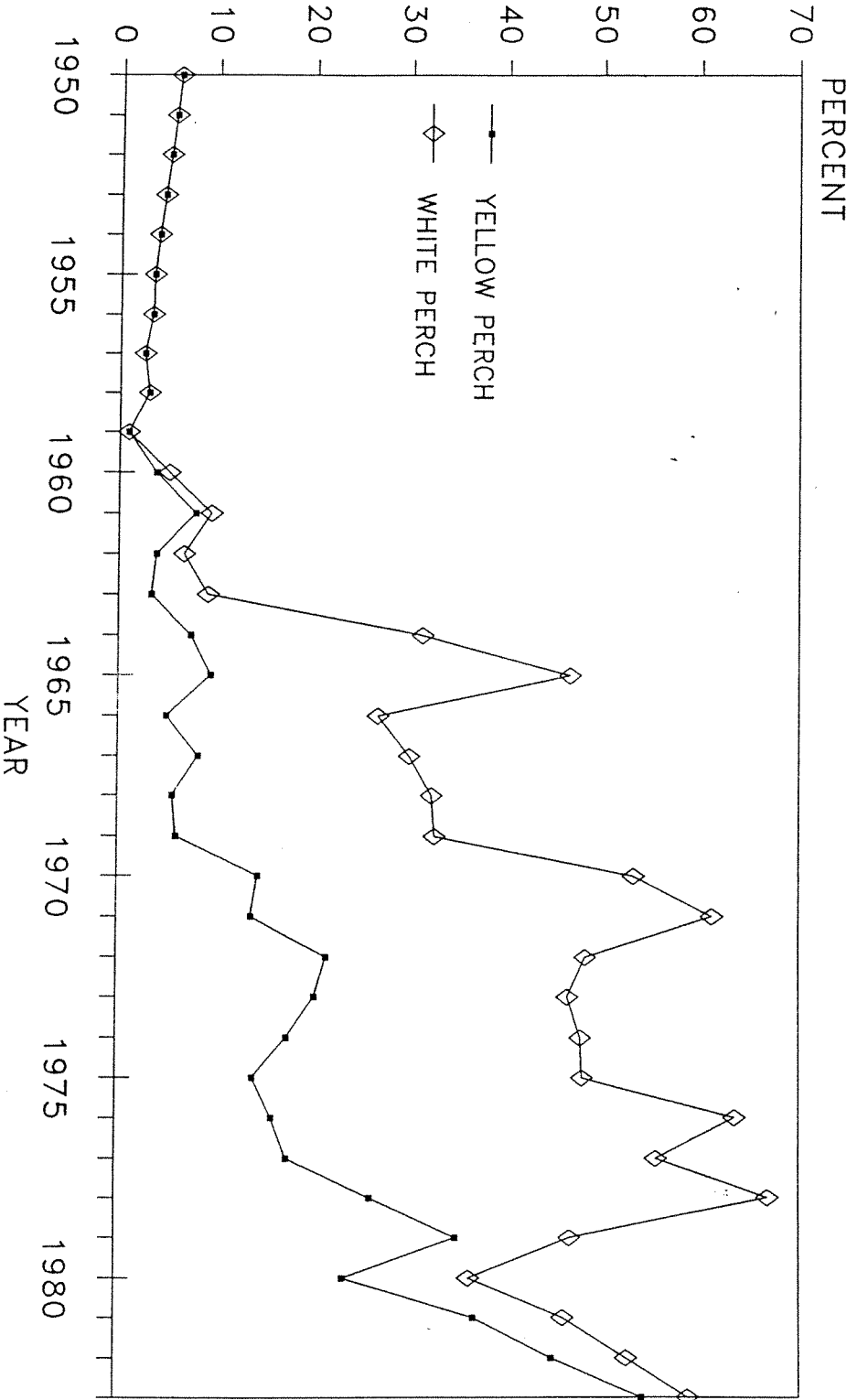

Source: Baldwin et al. (1979), Christie et al. (1973) and Ontario Ministry of Natural Resources (various issues)

FIGURE 30
COMMERCIAL GILNET EFFORT—WHITE PERCH
BAY OF QUINTE

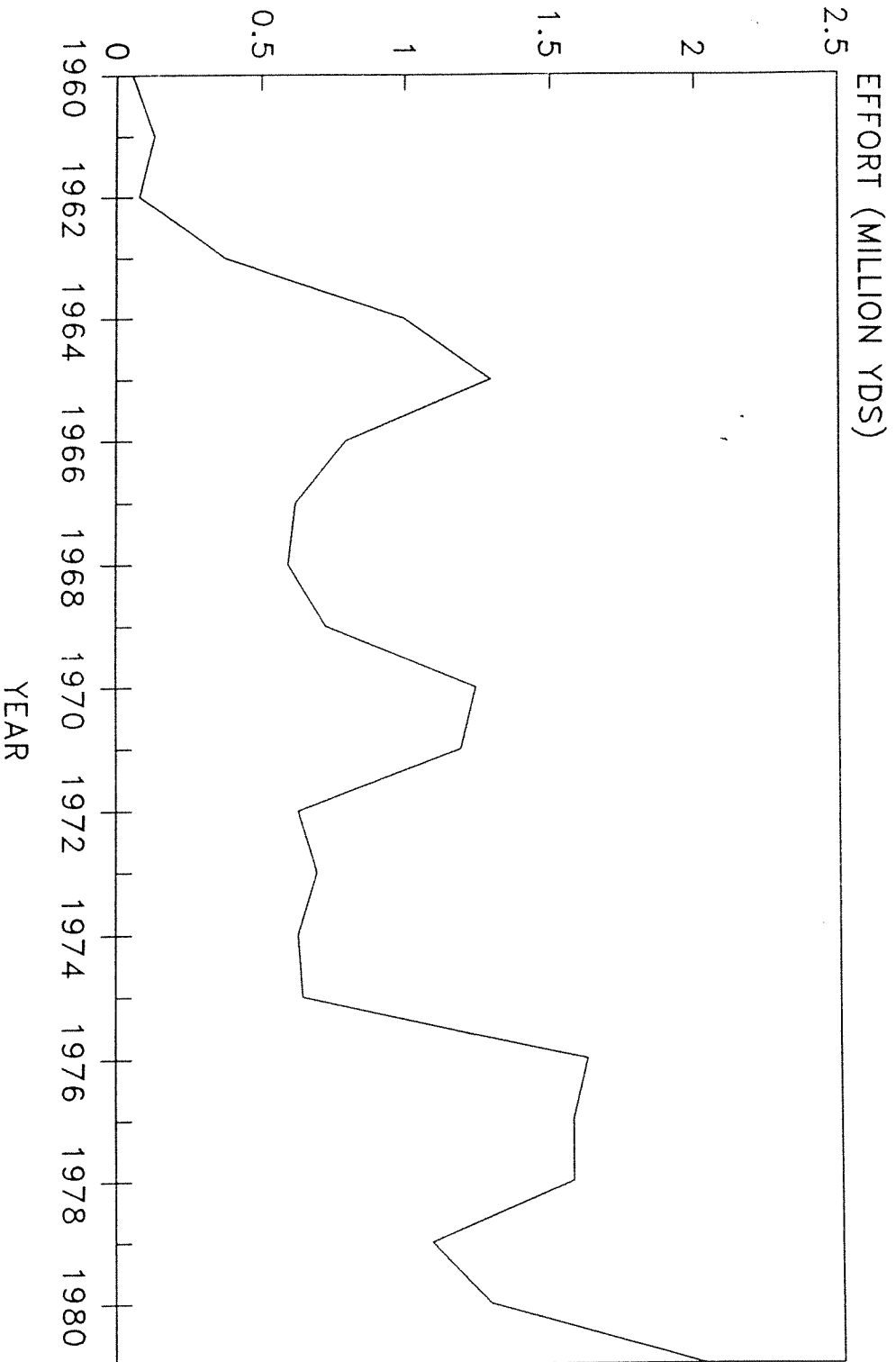

Source: Minns and Hurley (1986)

FIGURE 31
DISTRIBUTION OF COMMERCIAL EFFORT BY
NET SIZE, WHITE PERCH-BAY OF QUINTE

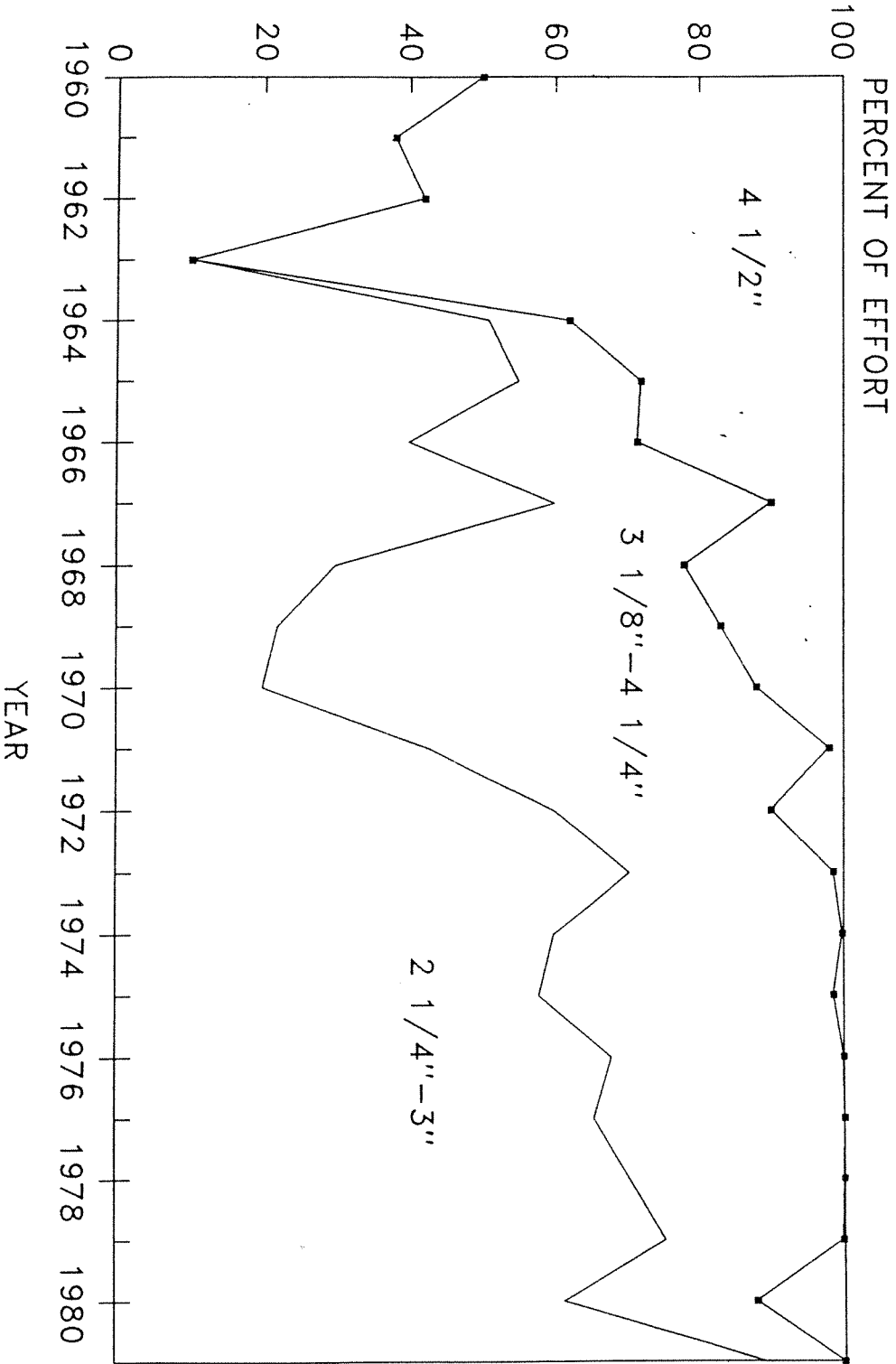

Source: Minns and Hurley (1986)

perch. In 1961, less than 10 percent of the commercial catch was yellow perch. By 1983, this had steadily increased to over 50 percent of the catch (Figure 29).

The Bay of Quinte has been the subject of research using gillnets for over thirty years. As such, the data collected can be used to examine the relative abundance of various fish species present in the bay. Using this experimental data Hurley and Christie(1977) provided an analysis of the bay before phosphorus control. Hurley(1986) extended this analysis to examining relative fish abundance after phosphorus controls were implemented. Figure 32 shows the catch per unit of gillnet effort for white and yellow perch over the 1958-1983 period. In terms of white perch, there was a steady increase in abundance as shown by a 390 percent increase in the catch per unit of gillnet effort (CUGE) from 152 in 1958 to 747 in 1972. Since 1972 the CUGE decreased to a low of 20 in 1982. In comparison, the CUGE for yellow perch remained relative constant over the 1958-1978 period. The average for this period was 211 with a standard deviation of 78. This compares with a mean CUGE of 353 and standard deviation of 213 for white perch.

6.1.2 Value of Commercial Fish Production in the Bay of Quinte

In order to evaluate recent trends in the value of production, ex-vessel prices were obtained from the Ontario Ministry of Natural Resources (OMNR, various issues) for the 1956-1983 period. Multiplying these prices by reported landings enabled us to estimate the total value of commercial landings.¹⁶ Figure 33 portrays the time series of the value of commercial

¹⁶The discussion of the value of the Bay of Quinte commercial harvest is expressed in terms of nominal Canadian dollars.

FIGURE 32
CATCH PER UNIT GILLNET EFFORT—YELLOW
PERCH AND WHITE PERCH, BAY OF QUINTE

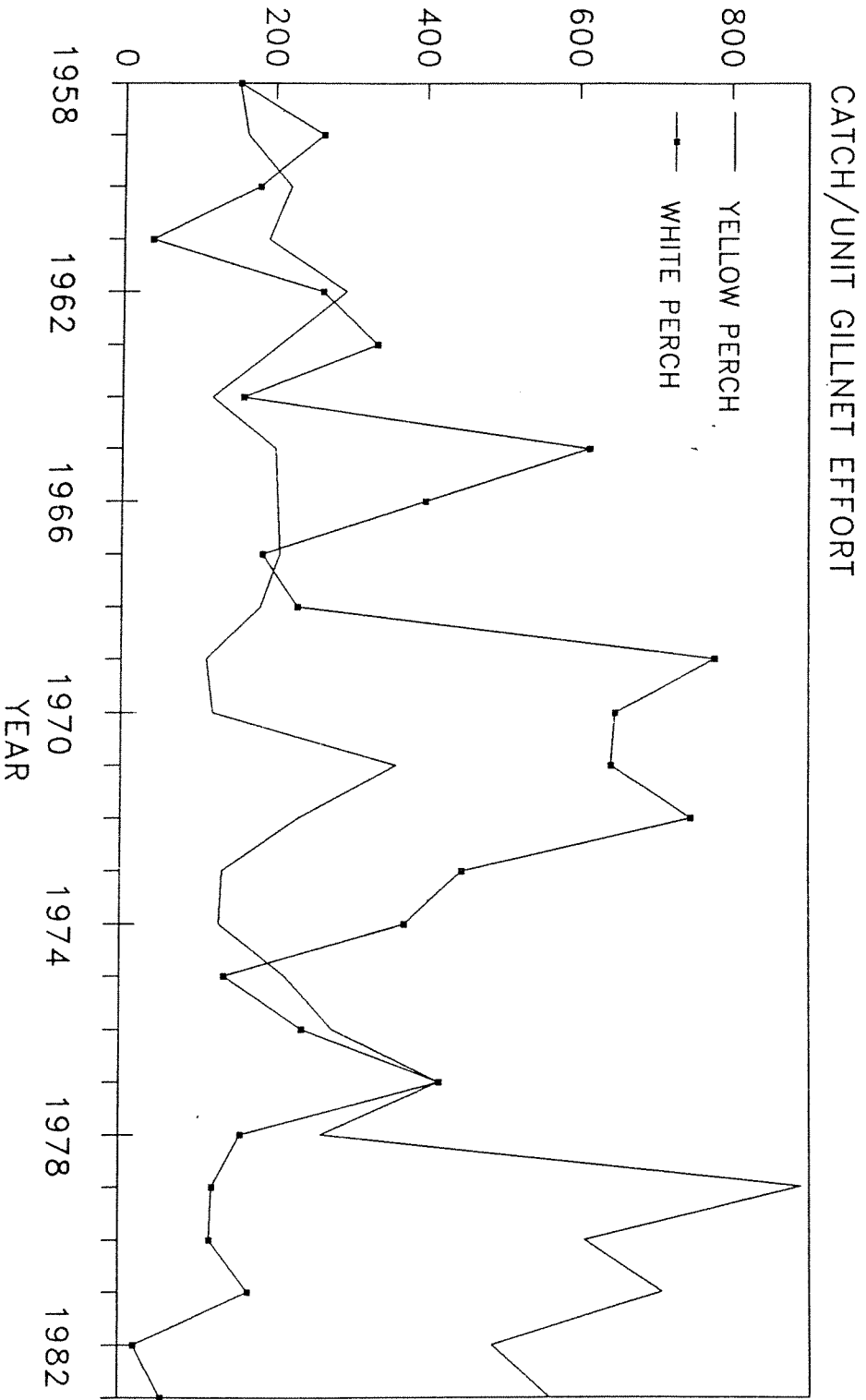

NOTE: THESE ARE RESEARCH CUGE RESULTS
Source: Hurley and Christie (1977) and
Hurley (1986)

FIGURE 33
TOTAL VALUE OF COMMERCIAL HARVESTS
LAKE ONTARIO AND BAY OF QUINTE

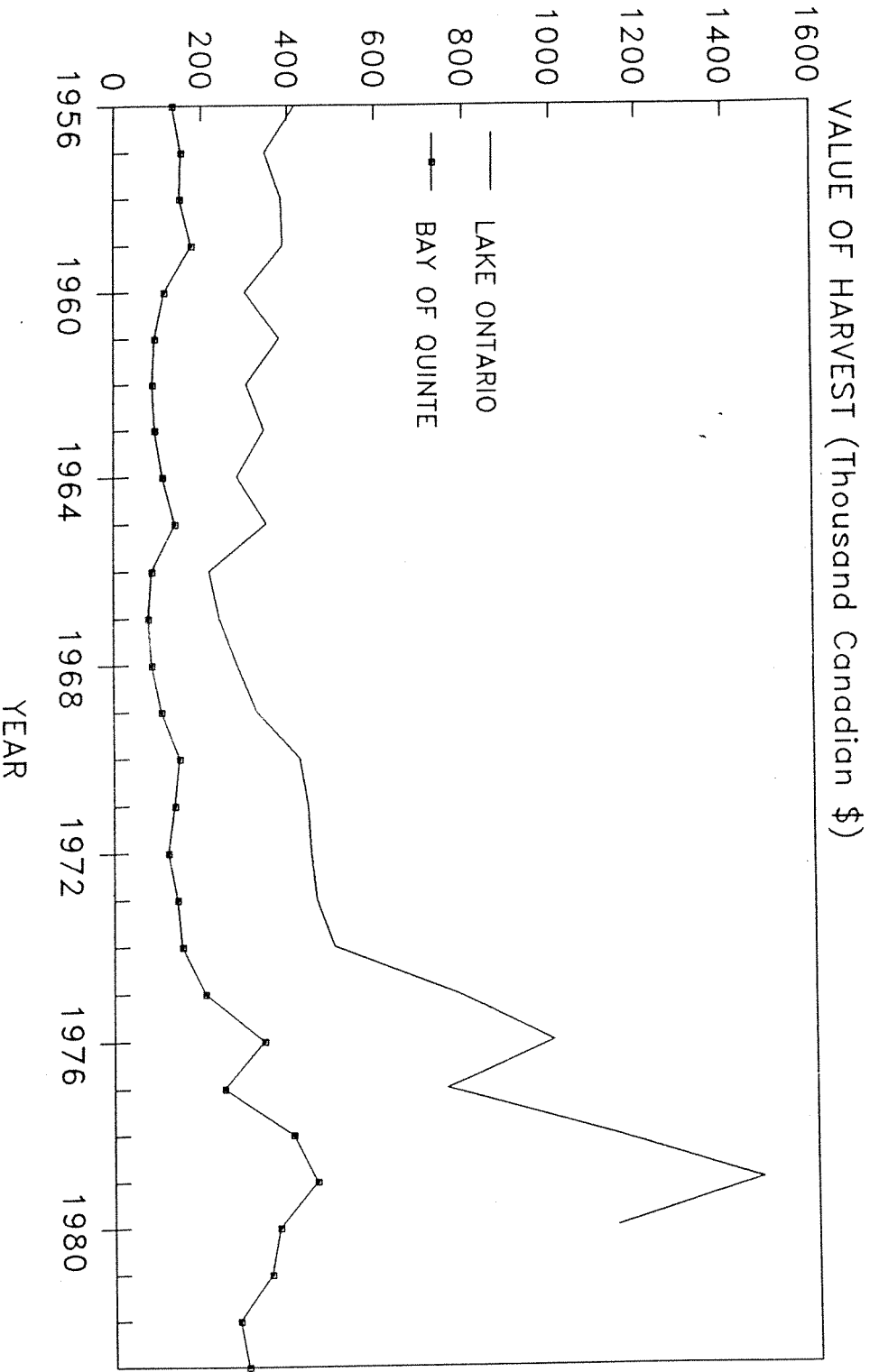

Source: Ontario Ministry of Natural Resources (various issues)

harvest for both the Bay of Quinte and the entire Lake Ontario fishing industry. From this figure we see a close relationship between the value of Lake Ontario and Bay of Quinte harvests. Prior to the early 1970's, the value of commercial fish harvests in the Bay of Quinte was fairly stable at \$150,000-\$200,000. Since then, there has been a trend of increased value of production. In 1979, the maximum value of over \$450,000 was recorded.¹⁷

Part of the increase in value observed over the last decade can be explained by general inflationary factors. Deflating the time series of ex-vessel prices we see in Figure 34 that the total value of landings has remained relatively constant since the mid-1950's. With a mean value of \$154,000 over this period (1971 \$), the coefficient of variation was .297 compared to .573 for the undeflated series. The undeflated mean value over this period was \$193,000.

Similar to the results presented with regard to the level of harvest, we partitioned the value of production by major species categories. In Figure 35, we see that concurrent with increased levels of eutrophication prior to the mid-1970's, the composition of the commercial catch has changed dramatically. With the collapse of the whitefish fishery which represented 40 percent of total value in 1956, there has been a corresponding increase in the importance of the white and yellow perch fisheries, although in recent years, the contribution of the white perch catch to total value has been declining. Currently, yellow perch contribute the most to total landing values accounting for 39 percent over the 1978-1983 period. The decline in the white perch fishery in the late 1970's had resulted in eel

¹⁷Over the 1956-1969 period, the standard deviation of the total value of Bay of Quinte landings was \$30,000. Since 1970, the standard deviation has increased to over \$110,000.

FIGURE 34
CURRENT AND DEFLATED VALUE OF COMMERCIAL
HARVEST--BAY OF QUINTE

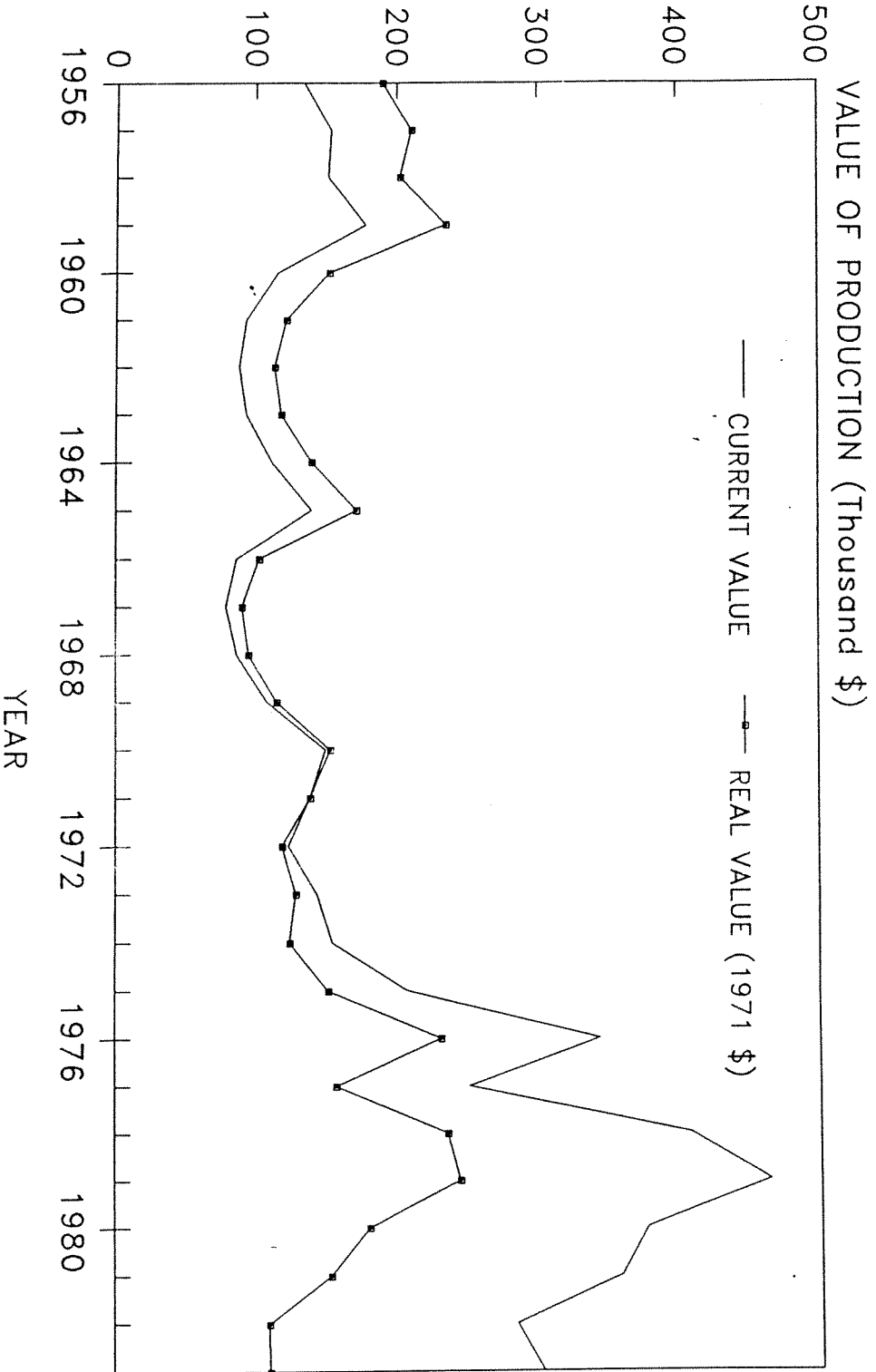

Source: Ontario Ministry of Natural Resources (various issues)

FIGURE 35
 DISTRIBUTION OF TOTAL VALUE OF HARVEST
 BY FISH SPECIES, BAY OF QUINTE

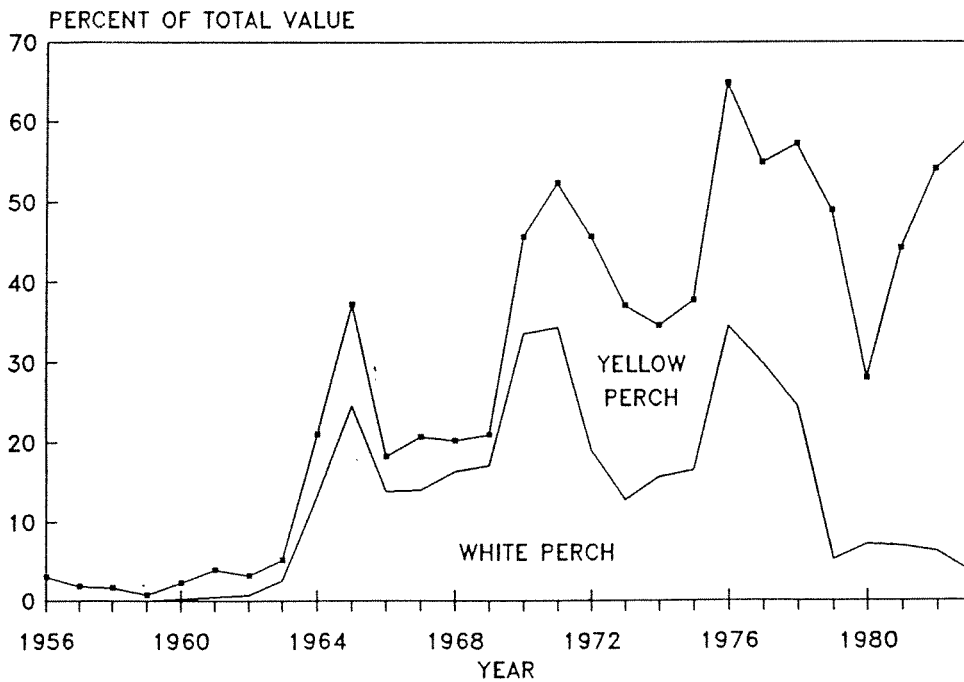
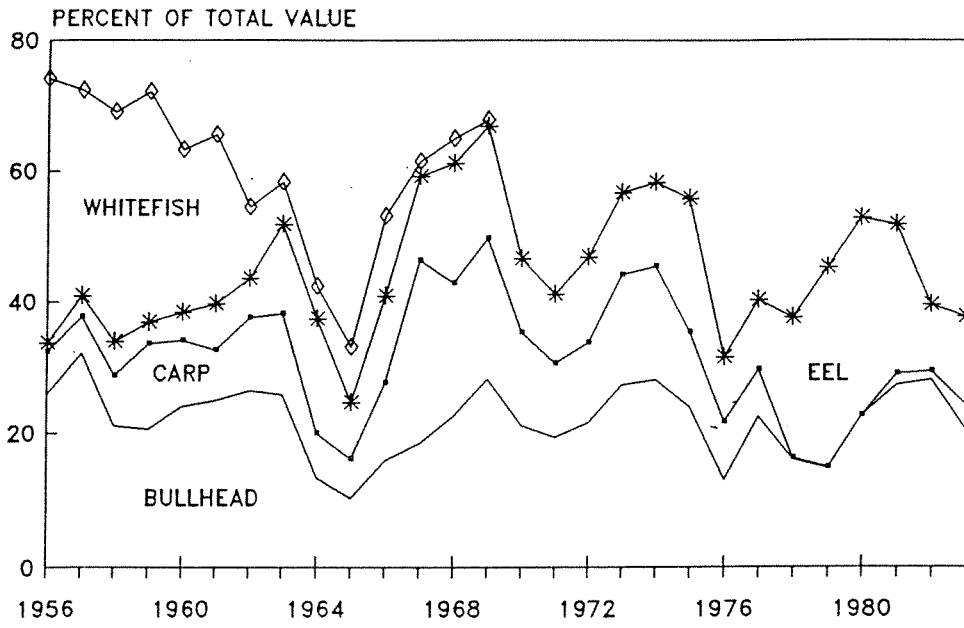

Source: Ontario Ministry of Natural Resources (various issues)

and catfish to contribute significant relative amounts to total value.¹⁸

6.1.3 Current Status of the Sport Fishery in the Bay of Quinte

The primary fish species in terms of the Bay of Quinte sportfishery is the walleye. In the late 1950's and early 1960's, the angler catch of walleye was estimated to equal the commercial catch (Hurley and Christie, 1977 p.183). Other important species for the sport fishery are yellow perch, northern pike and smallmouth bass. Unfortunately, creel census data could not be obtained for the pre-1978 period. To obtain an indication of the current status of the sport fishery, Table 23 presents the result of several creel surveys conducted over the 1981-1986 period.¹⁹ The results of both summer and winter creel surveys are presented in this table. Estimates of both harvest and fishing effort (angler-hours) are also given. In terms of the annual walleye harvest, most of the harvest occurs during the summer months. Less than 10 percent of the harvest occurred in the winter months in 1982 compared to 16 percent in 1986.

Schaner (1987) extrapolates the results presented in Table 23 to obtain total yearly estimates of fishing effort and harvest of walleye (Table 24). These estimates show a consistent increase in fishing effort over 1981-1986 for both the summer and winter months. The author then combines estimates of annual harvest and fishing effort to form estimates of the catch per unit effort (CPE) for the four major species for both summer and winter (Table 25). For the summer months, except for smallmouth bass, the CPE was the

¹⁸Prior to the 1970's the "other" category shown in Figure 38, was predominated by walleye. From 1956 to 1969, walleye accounted for an average 17 percent of the value of the bay's commercial harvest.

¹⁹Comparisons across years should not be made in Table 26 due to differences in the extent of coverage.

Table 23. Seasonal Sportfishing Harvest by Fish Species, Bay of Quinte 1981-1986.

	1981	1982	1984	1985	1986
Summer Creel Surveys					
Seasonal Coverage(mo.)	7	6	2	2	4
Effort (angler hours)	319,697	376,268	224,667	220,257	490,103
Harvest (No.)					
Walleye	150,000	89,012	60,855	69,710	120,525
Yellow Perch	13,031	16,735	12,980	5,136	12,175
Northern Pike	7,966	5,890	2,006	1,870	4,947
Smallmouth Bass	8,525	13,425	4,572	423	5,142
Winter Creel Surveys					
Seasonal Coverage(mo.)	-----Entire Season-----				
Effort (angler hours)	-----	66,523	106,764	-----	170,737
Harvest (No.)					
Walleye	-----	5,756	8,657	-----	23,768
Yellow Perch	-----	25,050	11,873	-----	1,218
Northern Pike	-----	172	355	-----	1,406

Source: Schraner(1987).

Note: Includes only estimated angler effort during the creel census period described in the first row.

Table 24. Total Yearly Walleye Sport Fishing Effort, Bay of Quinte 1981-1986.

Month	Year				
	1981	1982	1984	1985	1986
May & June	159,455	210,289	224,667	220,257	305,289
July	68,104	71,201	96,607	94,711	83,075
August	58,505	70,898	83,127	81,495	101,738
September	19,426	25,307	26,960	26,431	36,635
October	9,207	7,572	13,480	13,215	18,317
November	4,704	6,039	6,740	6,608	9,159
Total	319,401	382,306	451,581	442,717	554,213
Winter Fishery	N/A	95,033	128,117	N/A	170,737
Total	N/A	477,339	579,698	N/A	724,950

Source: Schaner(1987)

Note: Refer to Schaner(1987), p.2-6 for a detailed discussion of procedures used to estimate yearly effort.

Table 25. Catch per Unit Effort, Bay of Quinte Sport Fishery, 1981-1986
by Species

Species	Summer					Winter	
	1981	1982	1984	1985	1986	1984	1986
Walleye	.527	.266	.367	.414	.368	.081	.154
Yellow Perch	.321	.232	.164	.065	.140	.111	.010
Northern Pike	.035	.025	.015	.020	.029	.003	.009
Smallmouth Bass	.057	.094	.043	.022	.047	----	----

Source: Appendix A, Schaner(1987).

highest in 1981. As expected, the CPE was the largest for walleye for all years.

6.2 Water Quality Conditions in the Bay of Quinte

In 1975, the Bay of Quinte was identified by the International Joint Commission as an area of concern. The major problems cited were excessive nutrient loadings resulting in increased algal growth, low dissolved oxygen levels in bottom waters and localized areas of bacterial contamination (Bay of Quinte Remedial Action Plan Coordinating Committee, 1987 p.2). The resulting eutrophic conditions have negatively affected the use of the water resources for recreation purposes, as a source of water supply, and as fish and wildlife habitat. These conditions have also dramatically changed the type and quality of fisheries present.

6.2.1 Phosphorus Loadings in the Bay of Quinte

As noted in Robinson(1986) phosphorus has been identified as the major nutrient affecting the degree of eutrophication in the bay. The Canadian government instituted regulations reducing the phosphate content in laundry detergents (a major source of phosphorus) to 5 percent (as P₂O₂) by January

1, 1973. Following this action the Ontario Ministry of the Environment adopted the International Joint Commission's recommendations to reduce phosphorus loadings ever further requiring all communities discharging sewage into the bay to reduce phosphorus concentrations in their final effluent to 1 mg/L or less by December 1, 1975. It was not until the winter of 1977/78 that the new regulations actually became operational.

The effect of these reduced phosphorus loadings on the Bay of Quinte can be seen by examining the data presented in Table 26 and Figures 36-38. The variable values displayed in Table 26 show improved conditions in the Upper Bay since the implementation of phosphorus controls in 1977. Changes in conditions in the Middle Bay reflected general improvement but not to the degree indicated in the Upper Bay. In the Lower Bay, no strong evidence was found regarding the effects of reduced point source loadings.

Figure 36 shows the concentration of total phosphorus in the bay over the 1972-1985 period for the May/October period which tends to be the period of highest concentration and the time when most problems with algae growth occur. Problems with algae growth occur when phosphorus concentrations exceed 20 $\mu\text{g}/\text{l}$ (RAPCC, p.13). All portions of the bay have exceeded this level. In fact, the minimum levels recorded over this period for the Middle and Upper Bays occurred in 1979 with levels of 35 and 48 $\mu\text{g}/\text{l}$, respectively. Prior to the implementation of phosphorus controls, (pre-1978) the mean concentration was 78, 51 and 21 $\mu\text{g}/\text{l}$ in the Upper, Middle and Lower Bays, respectively. After point source controls were implemented mean concentration levels decreased to 50, 42 and 20 $\mu\text{g}/\text{l}$ in the Upper, Middle and Lower Bays, respectively. These changes are not surprising as noted by

Table 26. Mean May-October Values of Various Phosphorus Related Parameters, by Bay Location, 1972-1985.

	Pre-Phosphorus Load Reduction		Post-Phosphorus Load Reduction	
	1972-1977		1978-1983	1984-1985
Total Phosphorus ($\mu\text{g/L}$)				
Upper Bay	78		49.2	53.5
Middle Bay	51		41.3	44.0
Lower Bay	21		20.1	17.5
Phytoplankton (mm^3/L)				
Upper Bay	13.1		7.0	11.9
Middle Bay	8.7		6.5	7.3
Lower Bay	2.5		1.4	1.6
Chlorophyll a ($\mu\text{g/L}$)				
Upper Bay	27.4		14.4	20.9
Middle Bay	20.3		17.1	19.1
Lower Bay	7.5		5.9	9.5
Vertical Light Extinction (per m)				
Upper Bay	1.88		1.43	1.68
Middle Bay	1.43		1.32	1.36
Lower Bay	.64		.68	.55
Secchi Disk (m)				
Upper Bay	1.2		1.37	1.15
Middle Bay	1.4		1.42	1.30
Lower Bay	2.9		2.83	2.95

Source: Bay of Quinte RAP Coordinating Committee (1987), Table 7 p.28.

Robinson (1986) in that:

"All the major rivers flowing into the Bay of Quinte enter via the Upper Bay and most of the municipalities discharging treated wastes are also located on this section of the bay. Therefore, it follows that the Upper Bay is most affected by external loading and any response should be apparent first in the water chemistry of the Upper Bay" (p.55).²⁰

Figures 37 and 38 present seasonal averages of chlorophyll a concentrations and secchi disk depths for the three regions of the bay and for the bay as a whole over the 1972-1982 period. The Upper Bay has experienced a dramatic reduction in chlorophyll a concentration since the mid-1970's coincident with reductions in point source phosphorus loadings. Prior to 1978 the mean chlorophyll a concentration was 28 $\mu\text{g/L}$ compared to 16 $\mu\text{g/L}$ since phosphorus controls. With this large reduction, the average chlorophyll a concentrations in the Middle and Upper Bays are comparable. In contrast, the chlorophyll a concentration in the lower region has remained relatively constant with a mean level of 5.5 $\mu\text{g/L}$. Given the relative magnitudes of the chlorophyll a concentrations in the Lower and Upper Bays, the dramatic difference between the secchi disk depths should not be surprising. For the Upper and Middle Bays, there has been little change over the 1972-1982 period with average depths of 1.2 meters and 1.3, respectively. The average depth for the Lower Bay was 2.8 meters.

²⁰The upper bay has depths in the range of 4-8 m. The middle bay has average depths of 18 m while the lower bay depths of 60 m are not uncommon. This, characteristic again results in higher concentration levels in the upper portions (Robinson, 1986 p.51-52). Over 19 percent of the volume of the Bay of Quinte is contained in the upper bay. Ten percent is encompassed in the middle bay and 71 percent is contained in the Lower Bay (Minns et. al. 1986, p.61). Because of the volume of water contained in the lower portion of the bay, the dramatic decline observed in the upper portions of the bay are hidden if one uses the overall concentration coefficient as an indication of changes in water quality. For the 1972-1985 period the bay's average phosphorus concentration was 31 $\mu\text{g/L}$. The average concentration for the Upper, Middle and Lower Bays were 62, 46, and 20 $\mu\text{g/L}$, respectively.

FIGURE 36
MAY TO OCTOBER PHOSPHORUS CONCENTRATION
BY LOCATION—BAY OF QUINTE

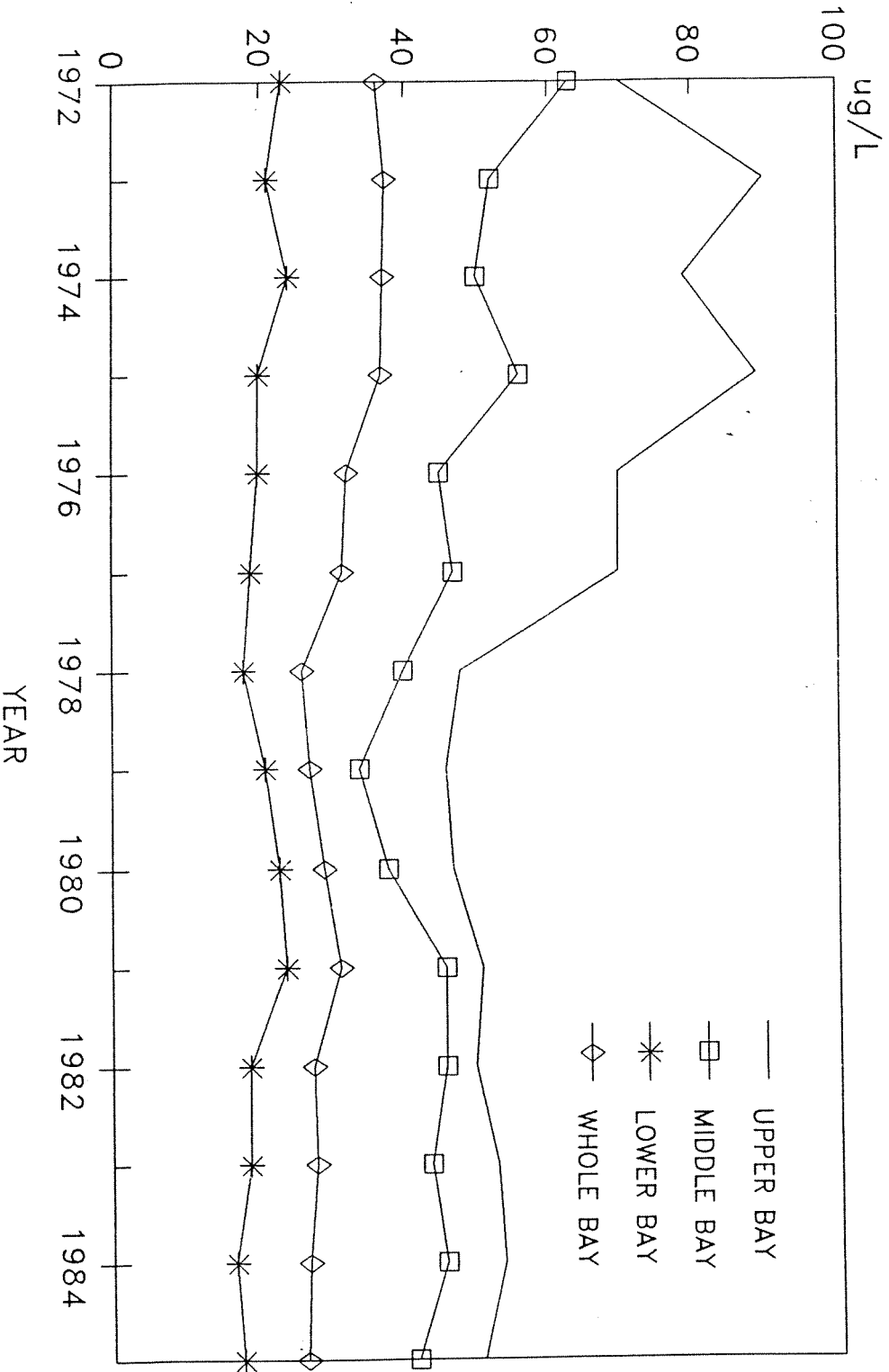

Source: Robinson (1986)

FIGURE 37
MEAN CHLOROPHYLL *a* CONCENTRATION
BAY OF QUINTE

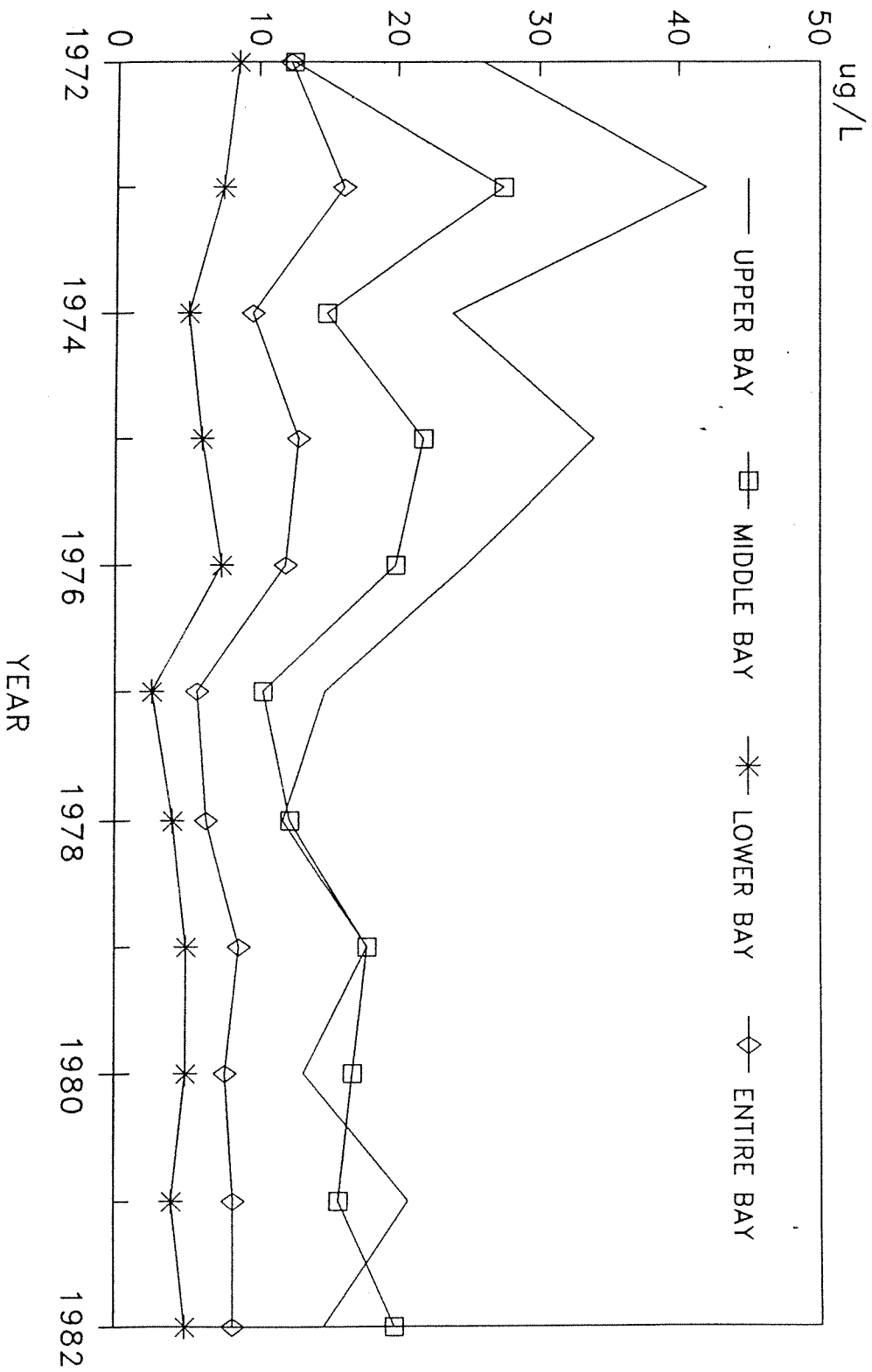

Source: Robinson (1986)

FIGURE 38
MEAN SECCHI DISK DEPTHS
BAY OF QUINTE

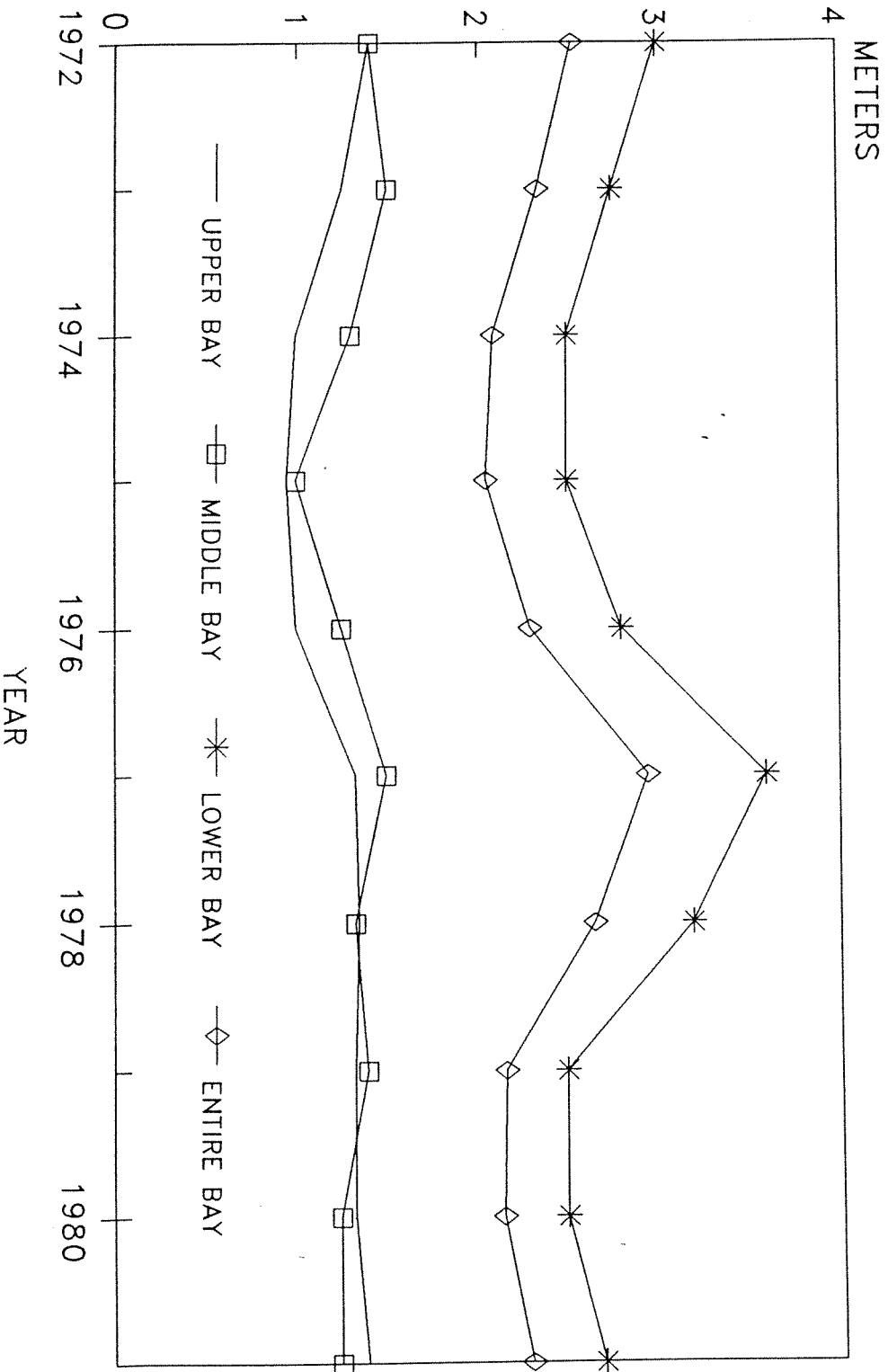

Source: Robinson (1986)

In terms of the concentration of dissolved oxygen in the bay's waters, the upper layers of the bay have always been greater than 5.0 mg/L, a value that is considered adequate for warm water species. Bottom water concentrations as low as 1 mg/L in the Middle Bay and 2.4 mg in the Lower Bay have been recorded.²¹ In order to understand the historical conditions in the bay, Table 27 presents the level of dissolved oxygen on various dates from 1945-1973 at Indian Point which is located on the Lower Bay. From this table we see a significant decrease in concentration in late summer and fall at the 40 meter level while the surface water has become increasingly supersaturated (Hurley and Christie 1977, p.1851).

Johnson and Owen (1971) showed that in 1968, only 40 percent of phosphorus loading originated from point sources. They suggested that the role of these point source loadings in terms of contributing to the eutrophication problem was greater than indicated by this proportion due to the fact that the loadings from non-point (river) sources (i) are flushed from the bay during the spring run-off and (ii) have had phosphorus concentrations that are lower than the concentrations found in the bay. As the authors state:

"...municipal-industrial wastes are high-concentration, low-volume inputs, which displace small amounts of nutrients from the bay. In contrast, river flows displace large amounts of nutrients from the bay. Increases in municipal-industrial inputs have a greater effect in increasing the bay concentrations, and, in general, cultural eutrophication is a result of increased concentrations of nutrients" (p. 845).

Johnson and Owen (1971) showed that in 1968, only 40 percent of phosphorus loading originated from point sources. They suggested that the

²¹In August 1980, a dissolved oxygen level of 1.3 mg/L was measured near Glenora.

Table 27. Values of Dissolved Oxygen, Indian Point 1945-1973

Date	Surface		40 m		
	mg/l	% saturated	mg/L	% saturated	
1945					
July	17	8.71	97	8.56	80
	24	8.71	101	7.85	69
	31	8.71	101	7.85	71
Aug.	9	8.85	104	7.14	66
	16	9.14	104	7.00	64
	29	8.71	99	6.42	58
Sept.	6	9.28	106	6.28	64
	29	9.99	101	6.85	69
1964					
July	16	8.67	94	7.80	68
	29	8.67	102	7.00	61
Aug.	14	9.46	98	5.60	51
	18	9.73	100	6.33	58
	28	9.20	98	5.40	49
Sept.	2	9.80	103	5.53	51
	10	9.46	100	3.87	34
	17	9.53	98	3.33	30
	22	10.46	108	5.00	45
1973					
July	5	10.4	119	8.3	75
Aug.	9	9.7	118	6.1	56
	28	8.4	98	5.2	45
Sept.	6	8.5	104	4.5	43
	18	8.7	93	4.1	36
	26	9.8	107	3.3	32

Source: Hurley and Christie 1977, Table 3, p.1852.

role of these point source loadings in terms of contributing to the eutrophication problem was greater than indicated by this proportion due to the fact that the loadings from non-point (river) sources (i) are flushed from the bay during the spring run-off and (ii) have had phosphorus concentrations that are lower than the concentrations found in the bay. As the authors state:

"...municipal-industrial wastes are high-concentration, low-volume inputs, which displace small amounts of nutrients from the bay. In contrast, river flows displace large amounts of nutrients from the bay. Increases in municipal-industrial inputs have a greater effect in

increasing the bay concentrations, and, in general, cultural eutrophication is a result of increased concentrations of nutrients" (p. 845).

Table 28, provides an indication of the importance of point source loadings in the late 1960's when taking into account the displacement effect mentioned above. The "net inputs" of the nutrients are defined as the amount of nutrient contained in the loading in excess of the amount of nutrient displaced to Lake Ontario in the equivalent volume of water (Johnson and Owen, 1971 p. 846). In terms of phosphorus loadings, the authors estimate that the contribution of point vs. non-point sources increases from 41 to 85 percent when comparing the absolute vs. net loading values. This has important implications given the economics of reducing highly concentrated point source loadings (Johnson and Owen, 1971 p.847).

Table 28. Absolute and Net Inputs of Phosphorus and Nitrogen Loadings (1000 lb/yr) Into the Bay of Quinte, by Source, 1968.

Source	Phosphorus				Nitrogen			
	Absolute	%	Net	%	Absolute	%	Net	%
Non-Point Sources								
Trent River	308.9	43.3	55.7	----	5890.2	60.9	827.0	37.3
Moira River	49.6	7.0	-2.8	----	1090.5	11.4	42.0	1.9
Salmon River	14.2	2.0	-6.9	----	457.2	4.7	35.7	1.6
Napanee River	24.5	3.4	5.0	----	515.3	5.3	125.6	5.7
Other	24.5	3.4	-.6	----	613.4	6.3	112.7	5.1
Sub-Total	421.6	59.1	50.4	14.8	8566.6	88.6	1143.0	51.6
Point Sources								
Trenton	96.8	13.4	96.5	28.1	320.9	3.3	315.0	14.2
CFB Trenton	14.3	2.0	14.2	4.2	57.7	.6	55.8	2.5
Belleville	144.3	20.3	143.3	42.3	626.2	6.5	605.6	27.4
Napanee	15.5	2.2	15.4	4.5	42.3	.4	40.4	1.8
Picton	16.4	2.4	16.3	4.8	41.8	.4	39.9	1.8
CFB Picton	3.1	.4	3.0	.9	9.7	.1	9.2	.4
Other Industry	1.4	.2	1.3	.4	6.5	.1	6.4	.3
Sub-Total	291.6	40.9	290.0	85.2	1105.1	11.4	1072.5	48.4
Total	731.2	100.0	340.4	100.0	9671.7	100.0	2215.5	100.0

Source: Johnson and Owen, 1971, Tables VI and Table V, p.845.

Note: Percentages were not calculated for the individual non-point sources due to the negative net input numbers.

Currently, there are 7 waste water treatment plants (WWTP's), six municipal plants and the Canadian Forces Base at Trenton. There are also 5 municipal water treatment plants (WTP's) and 5 industrial plants that discharge directly into the bay. Table 29 shows the distribution of annual loadings of suspended solids, BOD, and total phosphorus for municipal WWTP's and WTP's over the 1981-1986 period. In terms of the loadings of total phosphorus, the Belleville WWTP currently accounts for more than 40 percent of municipal loadings. This same plant accounts for 73 percent of BOD loadings. The Belleville WTP accounts for more than 50 percent of the TSS's.

Figure 39 provides an historical overview of phosphorus point source loadings in the Bay of Quinte over the 1965-1986 period. From an estimated maximum point source loading of more than 355 kg/day in 1968, the region has seen an 85 percent decline to the minimum loading of less than 45 kg/day. From 1966 to 1977 the annual average point source loadings was 259 kg/day. Since then, the average annual loading has averaged 73 kg/day.

Minns et al.(1986) develop nutrient budgets for the Bay of Quinte that are useful in comparing the importance of point vs non-point sources of nutrient loadings. Figure 40 shows both point and non-point loadings of phosphorus over the 1965-1981 period uncorrected for Lake Ontario exchange flows. Annual point source phosphorus loadings accounted from 16 to 38 percent of the total external loadings prior to 1978. Since then, point source loadings have accounted for 5 to 14 percent. The authors also develop budgets to compare annual vs. summer sources of phosphorus. Figure 41 shows the point and non-point phosphorus loadings over the summer months. Prior to 1977, point sources accounted from 20-54 percent of total external

Table 29. Mean Point Source Loadings of BOD, TSS and Phosphorus by Source, 1981-1986, Bay of Quinte (kg/yr)

Category	BOD		TSS		Total P	
	Amount	%	Amount	%	Amount	%
Municipal WWTP's						
Trenton	57,125	10.3	47,815	4.3	2,099	10.3
Belleville	407,340	73.5	194,180	17.6	8,249	40.5
Picton	6,570	1.2	10,038	.9	639	3.1
Deseronto	3,249	.6	4,745	.4	268	1.3
Napanee	47,268	8.5	79,935	7.3	6,205	30.5
Prince Edward	600	.1	600	.1	70	.3
CFB-Trenton	10,330	1.9	11,899	1.1	1,077	5.3
Sub-Total	532,480	96.1	349,212	31.7	18,607	91.3
Municipal WTP's						
Trenton	1,659	.3	48,941	4.4	108	.5
Belleville	15,963	2.9	607,381	55.1	1,437	7.1
Picton	2,291	.4	33,095	3.0	82	.4
Deseronto	312	.1	17,471	1.6	39	.2
Napanee	1,498	.3	46,450	4.2	100	.5
Sub-Total	21,723	3.9	753,338	61.3	1,766	8.7
Total Municipal						
Loadings	554,203		1,102,550		20,373	

Source: CANVIRO, 1988.

FIGURE 39
POINT SOURCE PHOSPHORUS LOADINGS
BAY OF QUINTE

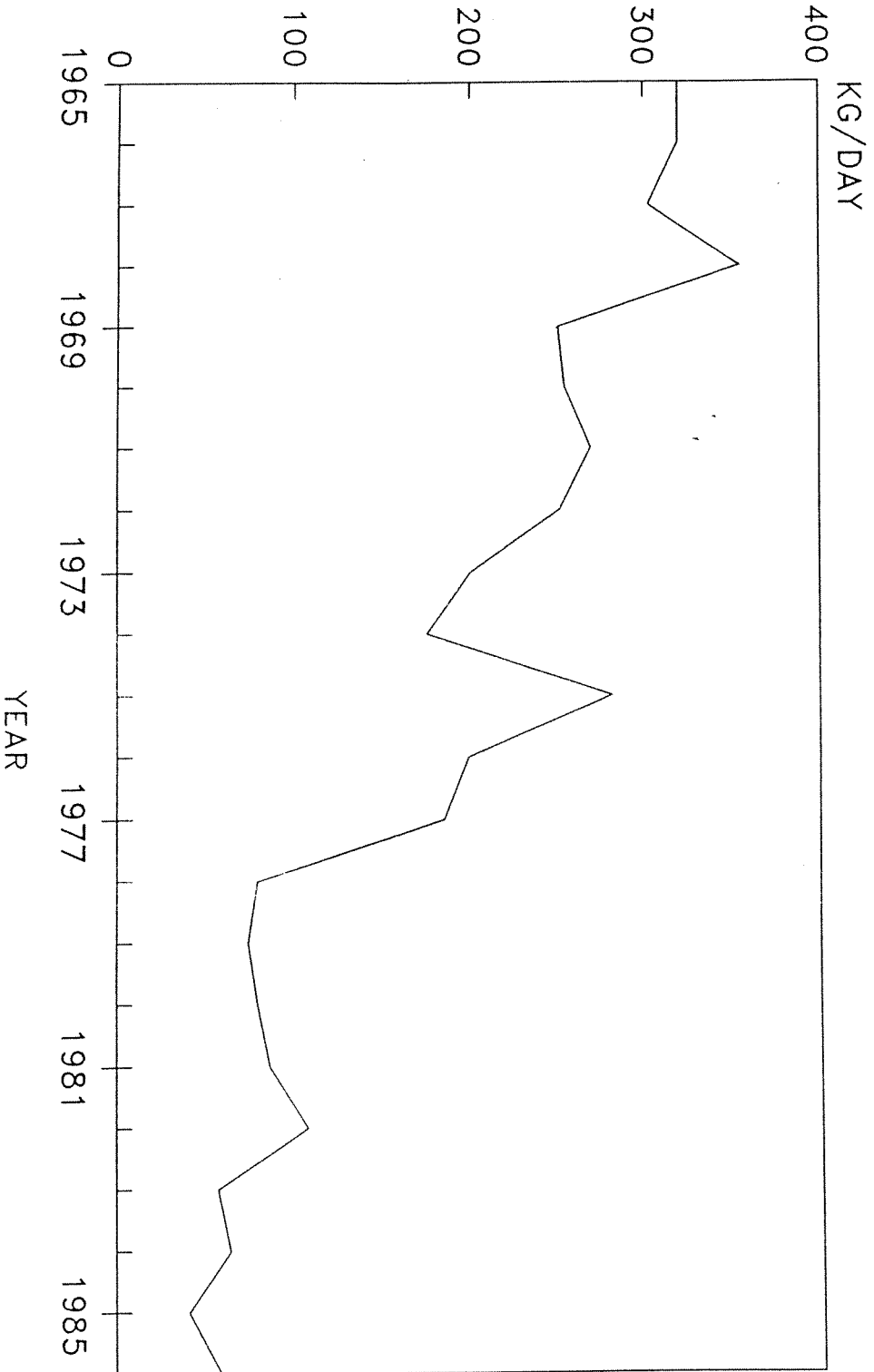

Source: Minns et al. (1986) and
CANVIRO (1988)

FIGURE 40
ANNUAL RIVER AND TOTAL PHOSPHORUS
LOADINGS—BAY OF QUINTE

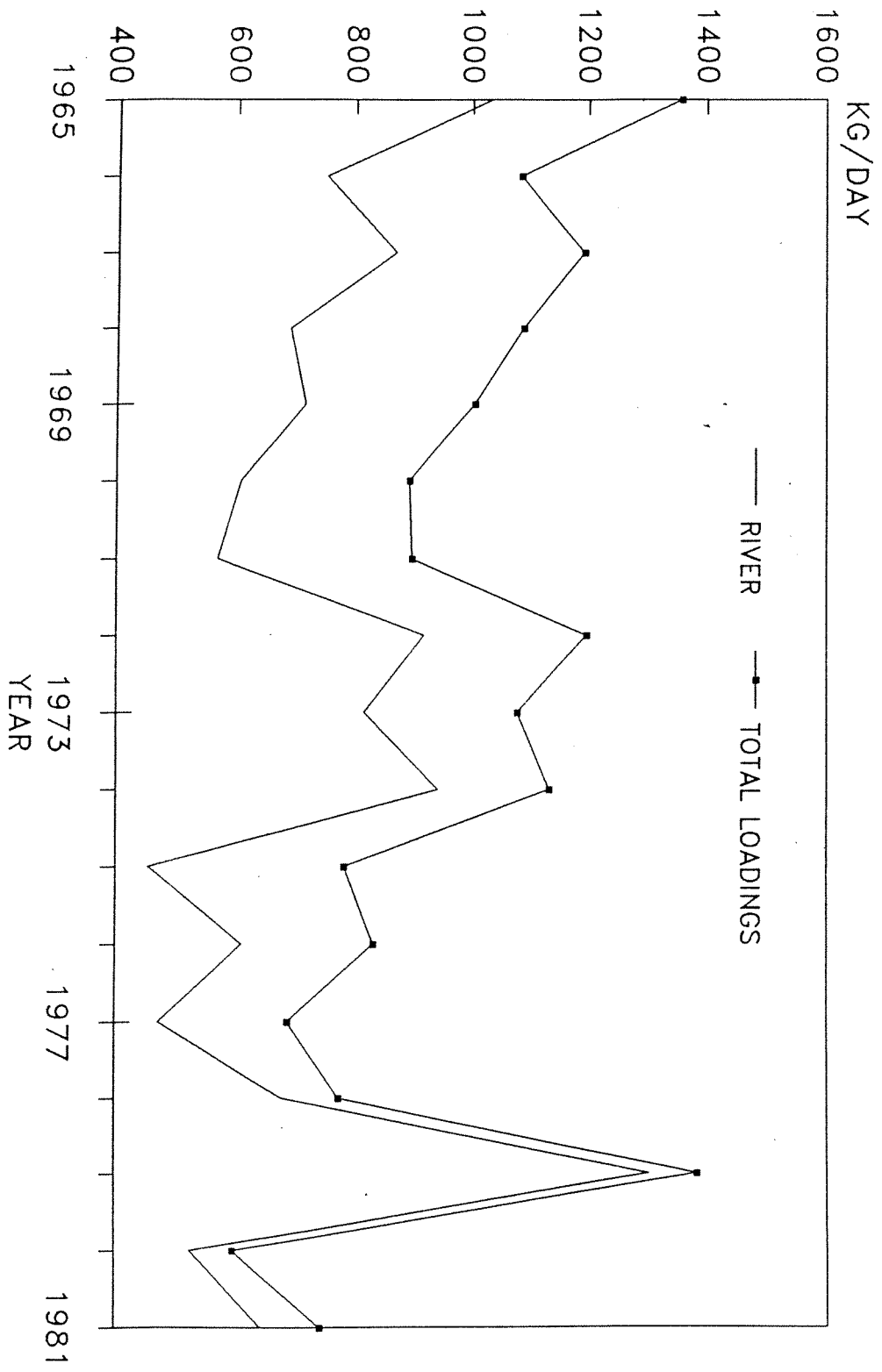

Source: Minns et al. (1986)

FIGURE 41
SUMMER LOADINGS OF PHOSPHORUS
BAY OF QUINTE

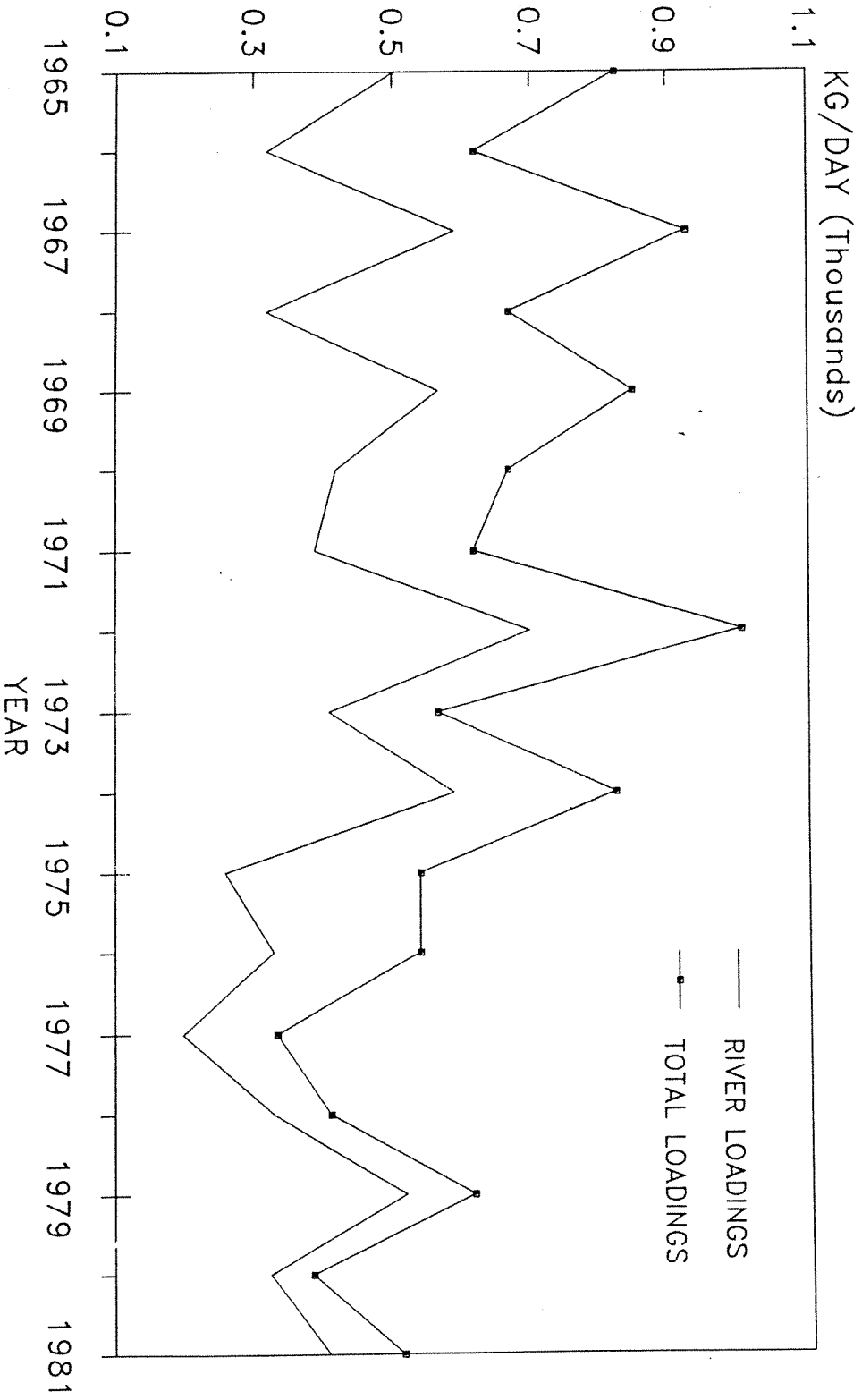

NOTE: Difference is point source loading
Source: Minns et al. (1986)

loadings compared to 9 to 18 percent since 1978.²²

In a recent study completed for the Bay of Quinte Remedial Action Plan Coordinating Committee (RAPCC), the distribution of the 1986 loading for each drainage basin was estimated. Table 30 provides a description of the characteristics of the drainage basins analyzed (Ecologistics, 1988). Figure 42 shows the locations of these drainage basins relative to the bay.

Table 31 provides estimates of the loadings of suspended solids and phosphorus to receiving streams, and an estimate of the amount that actually reaches the Bay of Quinte for each basin in the overall watershed. The difference between the loadings of phosphorus into the inland streams and that ultimately deposited into the bay reflects the degree to which suspended solids have settled or the phosphorus has been absorbed. Among the basins, the Kawartha contributes the greatest share of suspended solids and phosphorus to the receiving streams. This is mainly the result of the size of the basin. Among basins that are direct tributaries to the bay, the Lower Trent is the second largest but has farmland loadings greater than the largest basin, Moira, due to the low clay content of the soils and the high percentage of farmland that is cropland.

Two sets of estimates of ultimate loadings to the Bay of Quinte are presented in Table 31. In terms of the high scenarios, those basins that are directly tributary to the bay account for 75 percent of total delivered phosphorus and 70 percent of suspended solids while accounting for 51 percent of the total watershed area.

Seasonal loadings to receiving waters and delivery to the Upper Bay are

²²When viewing Figure 40 it should be remembered that these are gross loading values not corrected for the effect of the inflow of Lake Ontario waters or the dilution effects of alternative flushing rates over time.

Figure 42: Drainage Basin Locations, Bay of Quinte

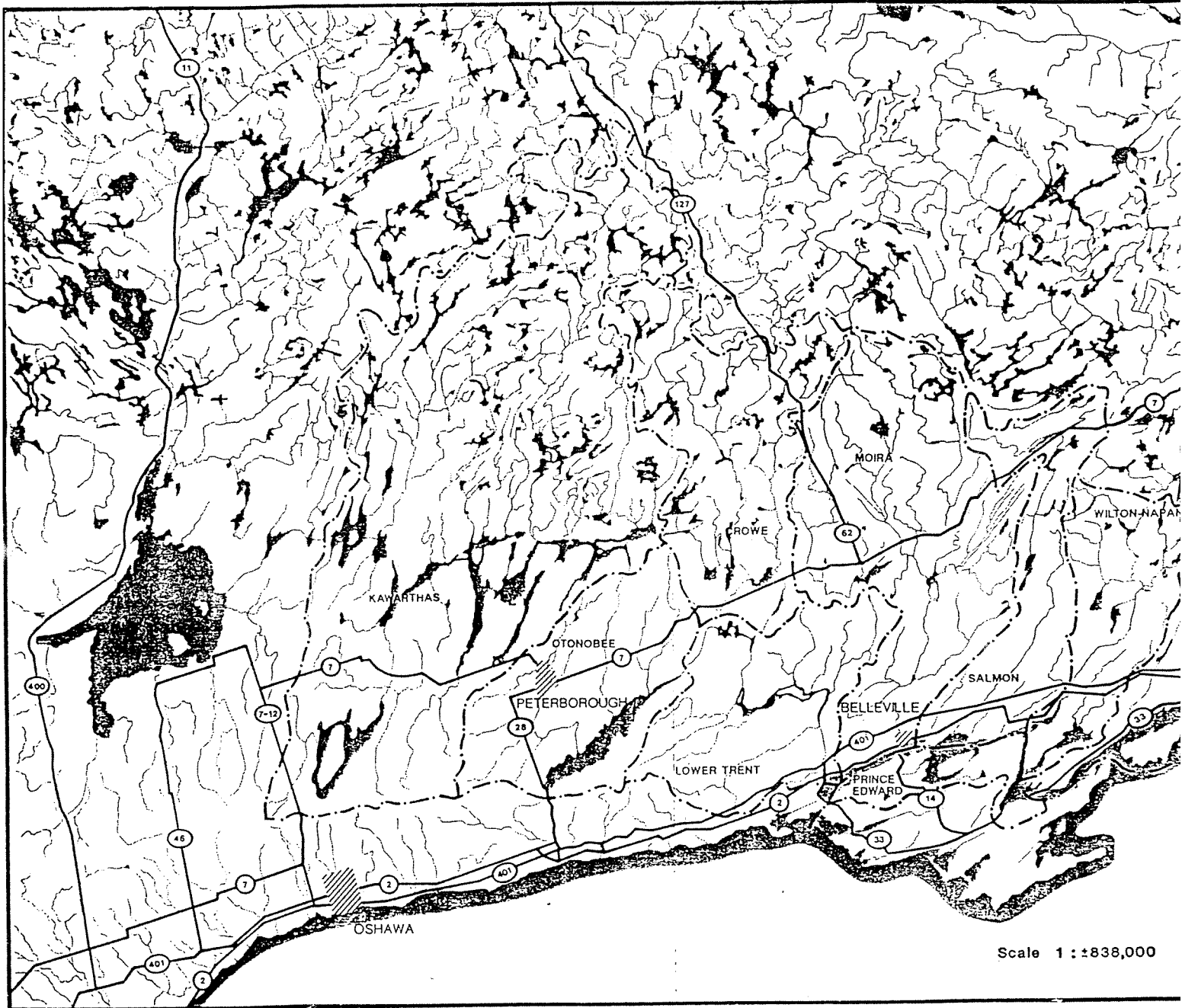

Source: Ecologistics (1988)

Table 30. Summary of Basin Characteristics Associated with the Bay of Quinte, 1986

Basin	Total Area		% Farmland			Clay Content of Soils (%)	Fertilizer Input (kg/ha)
	Total Area (ha)	% Farm Land	Row Crops	Pasture	Woodland		
Prince Edward County	37950	47	13	25	12	19	64
Wilton-Napanee ^a	124700	47	8	37	11	23	48
Salmon ^a	126900	37	6	44	9	22	34
Moir ^a	281100	25	7	35	16	20	44
Lower Trent ^a	158225	63	13	22	12	15	94
Crowe	208500	7	3	30	30	10	18
Otanabee	155500	56	9	29	11	20	93
Kawartha	661150	26	9	35	11	18	74
Total Watershed	1754025	32	9	32	12	18	59

Source: Ecologistics (1988) Table I-7.

Note: The superscript "a" identifies those basins that are directly tributary to the Bay.

Table 31. Phosphorus and Suspend Solid Loadings from Non-Point Sources by Watershed Basin

Basin	Farmland		Other Rural		Total		Delivered to Bay					
	Coefficient		Annual Loading		Annual Load		Annual Load		Annual Load			
	TSS	P	TSS	P	TSS	P	TSS	P	SS	P		
	(kg/ha)		(MT/yr)		(kg/ha)		(MT/yr)		Low	High	Low	High
Prince Edward County	101	.40	1779	7.1	386	1.0	2165	8.0	1082	2143	4.5	8.0
Wilton-Napanee ^a	112	.50	6470	28.9	1271	3.2	7740	32.0	3870	7663	18.0	31.8
Salmon ^a	86	.47	3996	21.8	1531	3.8	5528	25.7	2764	5473	14.6	25.4
Moir ^a	65	.41	4517	28.2	4030	10.1	8547	38.3	4273	8461	22.3	38.0
Lower Trent ^a	61	.32	6101	31.9	1107	2.8	7208	34.6	3604	7136	19.4	34.3
Crowe	25	.22	225	3.3	3686	9.2	3911	12.5	978	3833	5.8	12.3
Otonabee	84	.41	7273	35.9	1304	3.3	8577	39.1	429	1681	2.7	7.7
Kawartha	64	.37	11113	64.9	9285	23.2	20399	88.2	1050	3999	3.3	8.7
Total Watershed	73	.39	41474	221.9	22600	56.5	64074	278.4	18020	40389	90.6	166.1

Source: Ecologistics (1988), Tables I-9 and I-10.

Note: SS = total suspended solids
P = phosphorus
MT = metric tonne

The delivery ratios for the Low and High scenarios varied by basin. For suspended solids, except for the Crowe, Otonabee and Kawartha basins, the Low and High scenarios assumed .5 and .99 delivery ratios. For these three areas, the Low scenario delivery ratios were set at .25, .05 and .05 respectively. For the High scenario, the ratios were .98, .20 and .20, respectively. For phosphorus loadings, the delivery ratios also varied by basin with Prince Edward county and Salmon having values of .57, Wilton-Napanee and Lower Trent values of .56, Moira .58, Crowe .46, Otonabee .07 and Kawartha .04 for the Low scenario. For the High scenario all basins except for Otonabee and Kawartha were assumed to have delivery ratio values of .99. Otonabee was assumed to have a ratio value of .20 and Kawartha a value of .10.

presented in Table 32. More than 75 percent of the total loadings was received in the spring. Seventy-nine percent of the total ultimate loadings occurred in the Upper Bay. Combining these trends we see that more than 61 percent of all loading occurs in the Upper Bay during the spring months.

Figure 43 shows the distribution of phosphorus loadings (uncorrected for the inflow of Lake Ontario water) over the 1965-1981 period for total annual and summer loadings. Given the importance of non-point loadings of phosphorus, summer loadings averaged 27 percent of total phosphorus loadings. The average total annual loadings were 971 kg/day compared to 759 kg/day during the summer months.

Minns et al. (1986) develop phosphorus budgets that take into account the incursion of Lake Ontario water into the Bay of Quinte and the resulting phosphorus loadings. Figure 44 presents a comparison of the corrected and uncorrected phosphorus loadings in the Bay of Quinte. The difference between the two trends is due to the net external loadings from Lake Ontario to the Middle and Lower Bays. Over the 1965-1981 period, net external loadings of Lake Ontario water was estimated to account for 40 percent of total phosphorus loadings. This percentage ranged from a low of 23 percent in 1972 to a high of 64 percent in 1981.

The importance of Lake Ontario in determining the water quality of the Bay of Quinte varies between regions of the bay. To examine the differential effects of Lake Ontario water, the authors develop "corrected" phosphorus budgets for the three regions of the Bay of Quinte for the 1972-1977 and 1978-1981 periods. Figure 45 provides a representation of these phosphorus budgets both on an annual basis as well as for the summer

Table 32. Delivery of Suspended Solids and Phosphorus by Season, Basin and Bay Location (MT/YR)

	Spring		Summer		Fall		Total	
	SS	P	SS	P	SS	P	SS	P
<u>Basin Location</u>								
Prince Edward County	1650	6.1	129	.5	364	1.4	2143	8.0
Wilton-Napanee	5900	24.5	460	1.9	1303	5.4	7633	31.8
Salmon	4214	19.6	328	1.5	930	4.3	5473	25.4
Moira	6515	29.2	508	2.3	1438	6.5	8461	38.0
Lower Trent	5495	26.4	428	2.1	1213	5.8	7136	34.3
Crowe	2951	9.5	230	0.7	652	2.1	3833	12.3
Otanabee	1295	5.9	101	0.5	286	1.3	1681	7.7
Kawartha	3079	6.7	240	0.5	680	1.5	3999	8.7
<u>Receiving Waters</u>								
Upper Bay	24704	101.6	1925	7.9	5454	22.4	32083	131.9
Middle & Lower Bay	6396	26.3	498	2.0	1412	5.8	8306	34.1
<u>Total Watershed</u>								
	31099	127.9	2423	10.0	6866	28.2	40388	166.1

Source: Ecologistics (1988), Tables I-11 and Tables 1-12.

FIGURE 43
TOTAL PHOSPHORUS LOADINGS
ANNUAL AND SUMMER-BAY OF QUINTE

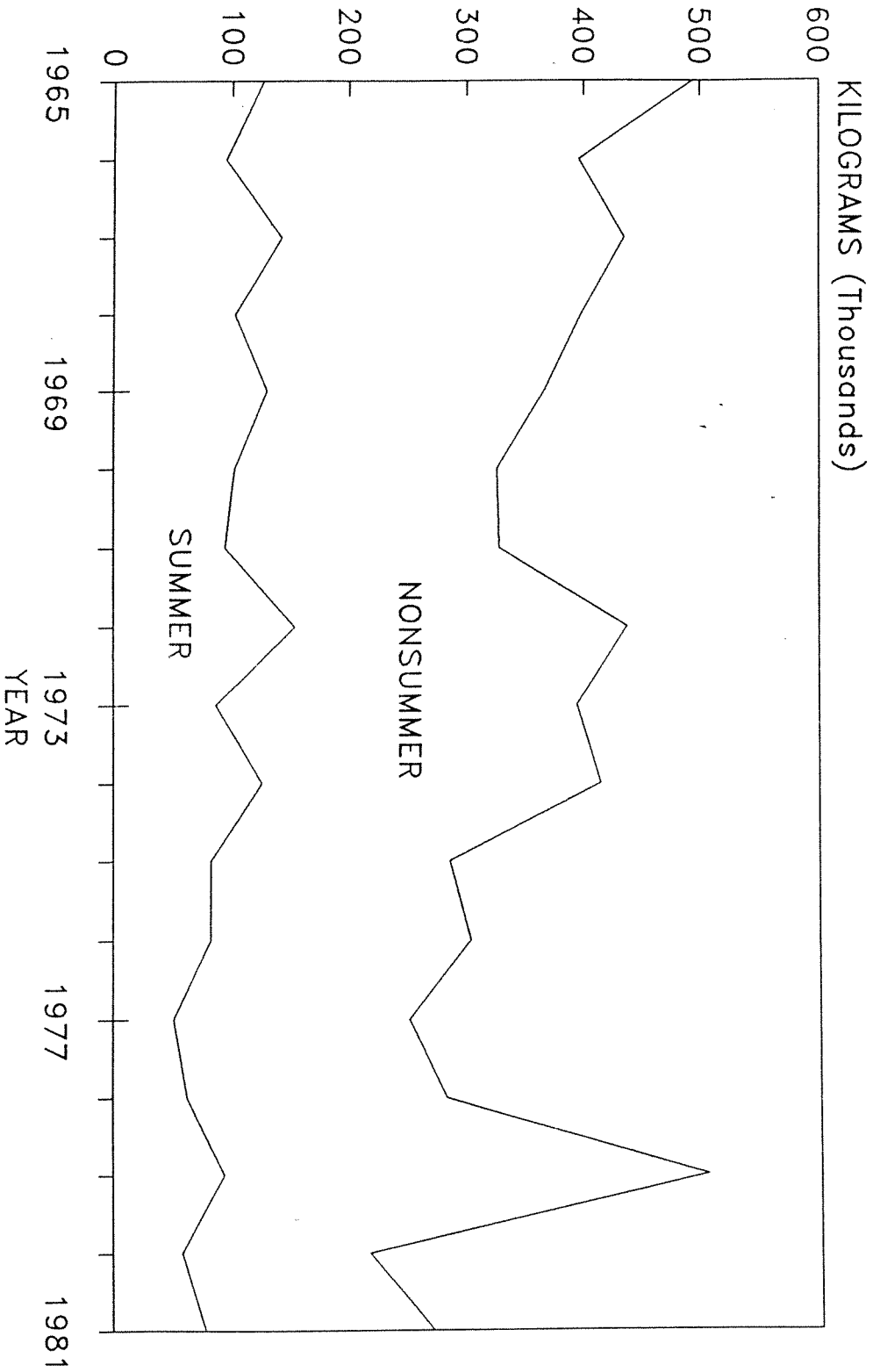

Source: Minns et al. (1986)

FIGURE 44
CORRECTED AND UNCORRECTED PHOSPHORUS
LOADINGS--BAY OF QUINTE

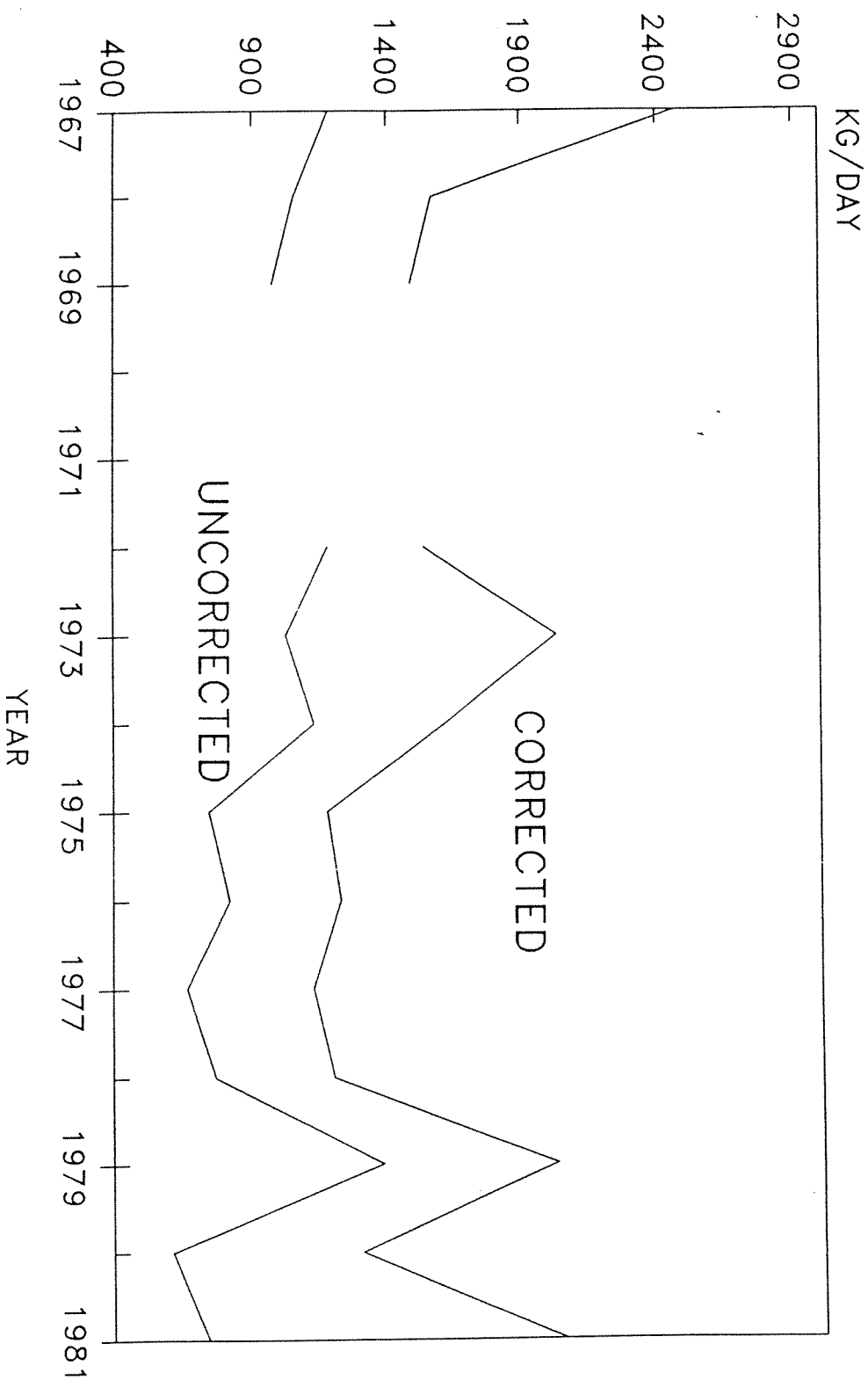

Source: Minns et al. (1986)

Figure 45: Phosphorus Budgets, Bay of Quinte 1972-1981

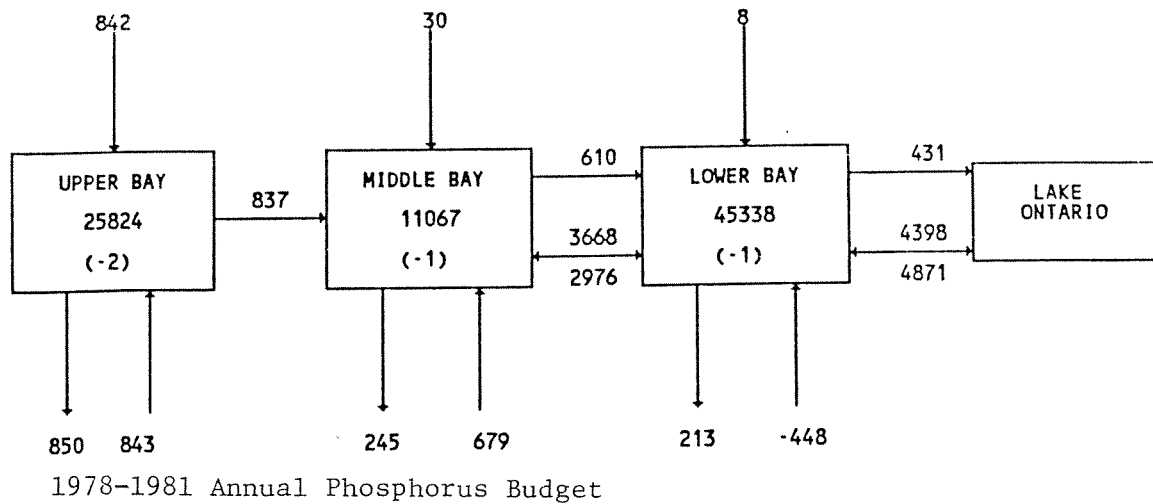
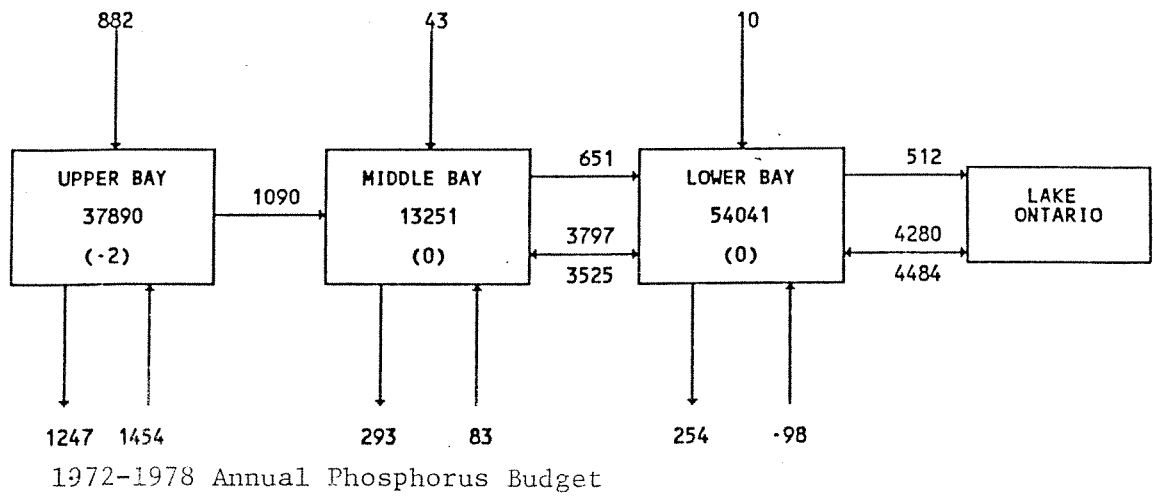

Source: Minns et al. (1986)

loadings. The numbers in this figure are in terms of kg/day.²³ In interpreting these figures, the inflow from watershed external point and non-point sources is represented by the flow from above each box. The flow from each box to below represents the loss of phosphorus due to sedimentation. The flow to each box from below represents the resuspension of phosphorus from existing sediment. There is a single linkage between the Upper and Middle Bay which is the flow of phosphorus from the Upper to the Middle Bay. There are two sets of linkages between the Middle and Lower Bays and the Lower Bay and Lake Ontario. The top linkage represents net Middle and Lower Bay outflows. The bottom linkages represent Middle/Lower and Lower/Lake Ontario exchange backflows. Within each box are estimates of the current inventory of phosphorus in each bay. The numbers in parenthesis gives estimates of the average annual change in these inventories.

This figure shows that (i) the phosphorus inventories throughout the bay have declined, (ii) sedimentation and reflux have remained relatively stable throughout the study period, (iii) Lake Ontario backflows dominate the flow of nutrients in the Middle and Lower Bay and (iv) prior to 1978, the Upper Bay was a net exporter of phosphorus; since then the loadings have equaled the withdrawals (Minns et al., 1986 p.71).

6.2.2 Nitrogen Loadings in the Bay of Quinte

As noted in Robinson(1986) there were major reductions in the concentration of total nitrogen in the bay after the imposition of phosphorus controls. The author notes:

"The overall decrease in [total nitrogen] was associated with a relatively large reduction in total organic nitrogen reflecting lower

²³For a detailed discussion of the estimation procedures used, refer to Minns et. al. (1986) p. 67.

algal biomass. The total inorganic nitrogen levels increased accordingly. In both the Upper and Lower Bays, prior to phosphorus controls, there were extended periods when the total inorganic supply was almost exhausted. After 1978, particularly [in the Lower Bay], total inorganic nitrogen levels were not reduced as severely. This represents an under-utilization of the available nitrate because of lower algal densities. Ammonia levels were virtually unaffected" (p. 52-53).

Figure 46 shows the trends in total nitrogen concentrations over the 1972-1985 period. The mean concentration prior to P control was .85 mg/L in the Upper Bay. Since then the mean has decreased to .73 mg/L, a 14 percent decline. Similarly, for the Middle Bay, the mean has decreased 4 percent. The mean concentration in the Lower Bay increased from .45 mg/L to .53 mg/L. The overall concentration coefficient value has remained relatively constant with a mean value of .55 mg/L prior to P control and .58 mg/L after P control. The coefficient of variation across the entire time period encompassed by this figure was relatively low, .07.

In contrast to point source phosphorus loadings, point source nutrient loadings remained relatively stable (Figure 47). Over the range of data presented in this figure, point sources accounted for 6.2 percent of total nitrogen loadings.²⁴

Minns et al. (1986) develop nitrogen budgets for the bay that account for the incursions of Lake Ontario water similar to those developed for phosphorus. Figure 48 shows the percentage of total nitrogen loadings into the bay originating from point and non-point sources within the Bay of Quinte watershed. The patterns exhibited over both the summer and annual

²⁴Similar to the analysis provided by Johnson and Owen (1971) in their analysis of the "net inputs" of phosphorous discussed earlier, Table 24 also presents a comparison of the raw input vs net input of nitrogen into the bay for 1968. In their analysis, the proportion of point source loadings increased from 11 percent of the raw input to more than 48 percent of net loadings.

FIGURE 46
TOTAL NITROGEN CONCENTRATION
BY LOCATION, BAY OF QUINTE

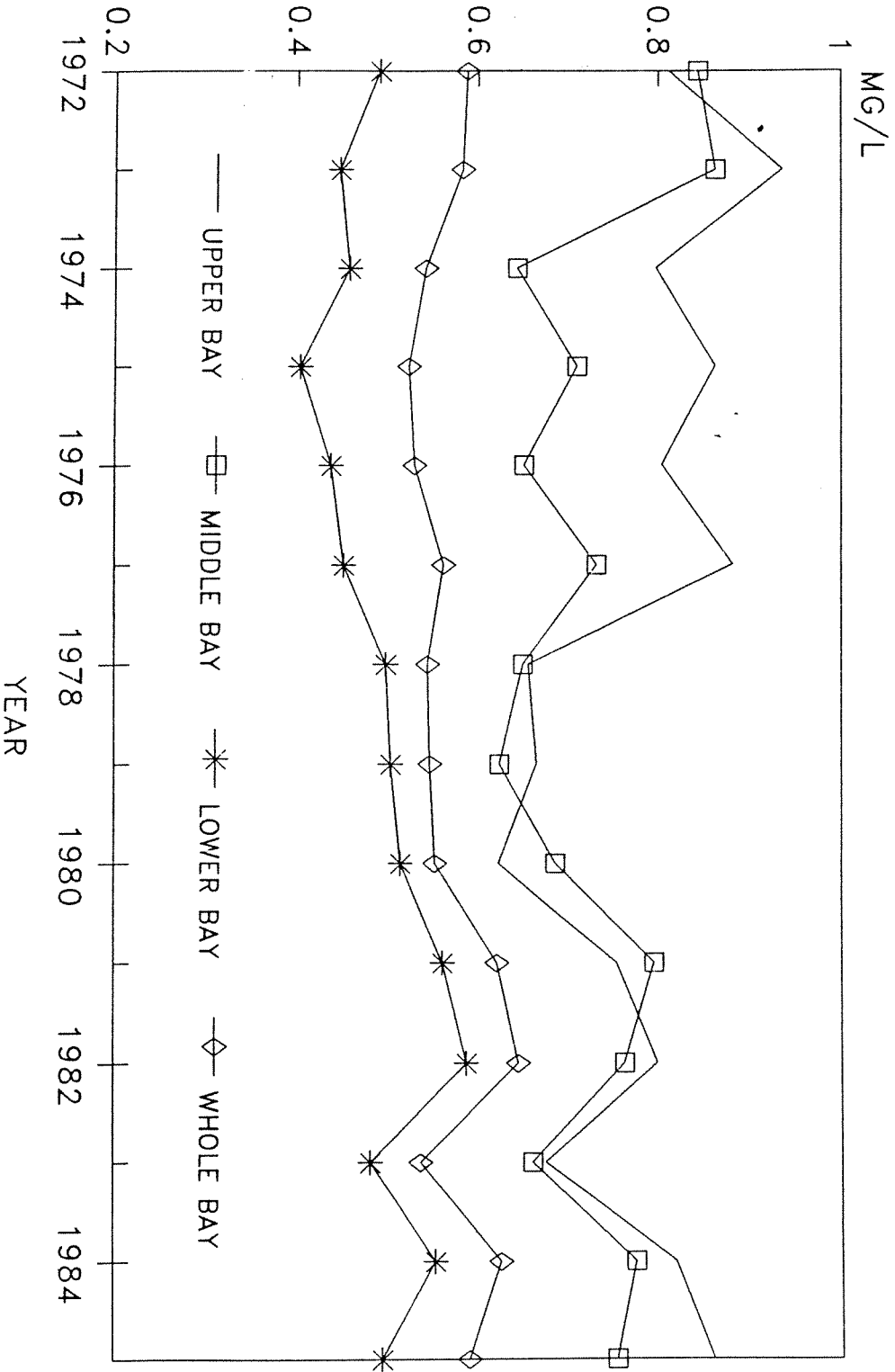

Source: Robinson (1986)

FIGURE 47
TOTAL AND RIVER NITROGEN LOADINGS
BAY OF QUINTE

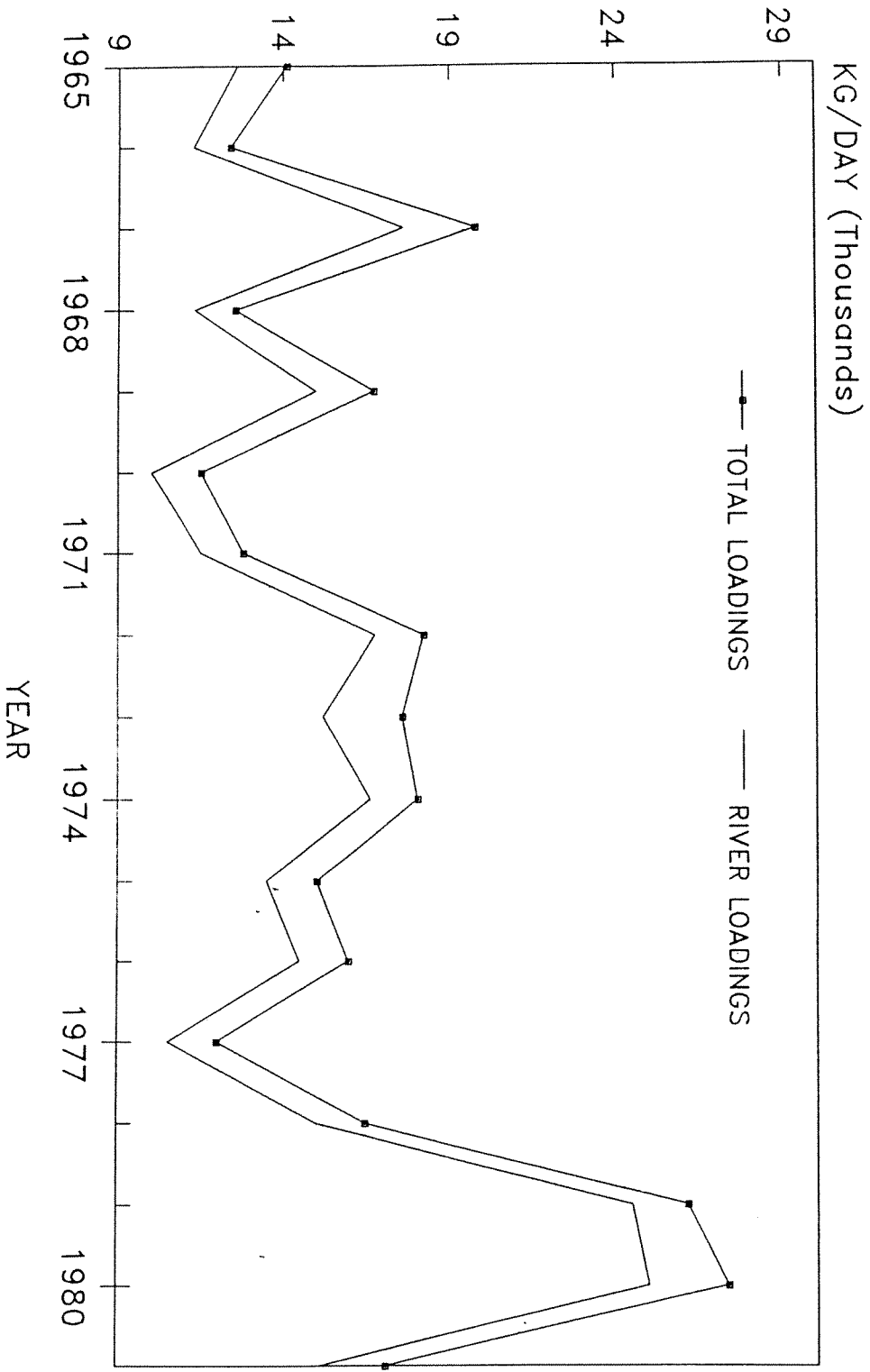

Note: Difference is point source loading
Source: Minns et al. (1986)

FIGURE 48
PERCENT OF TOTAL NITROGEN LOADINGS FROM
BAY OF QUINTE WATERSHED SOURCES

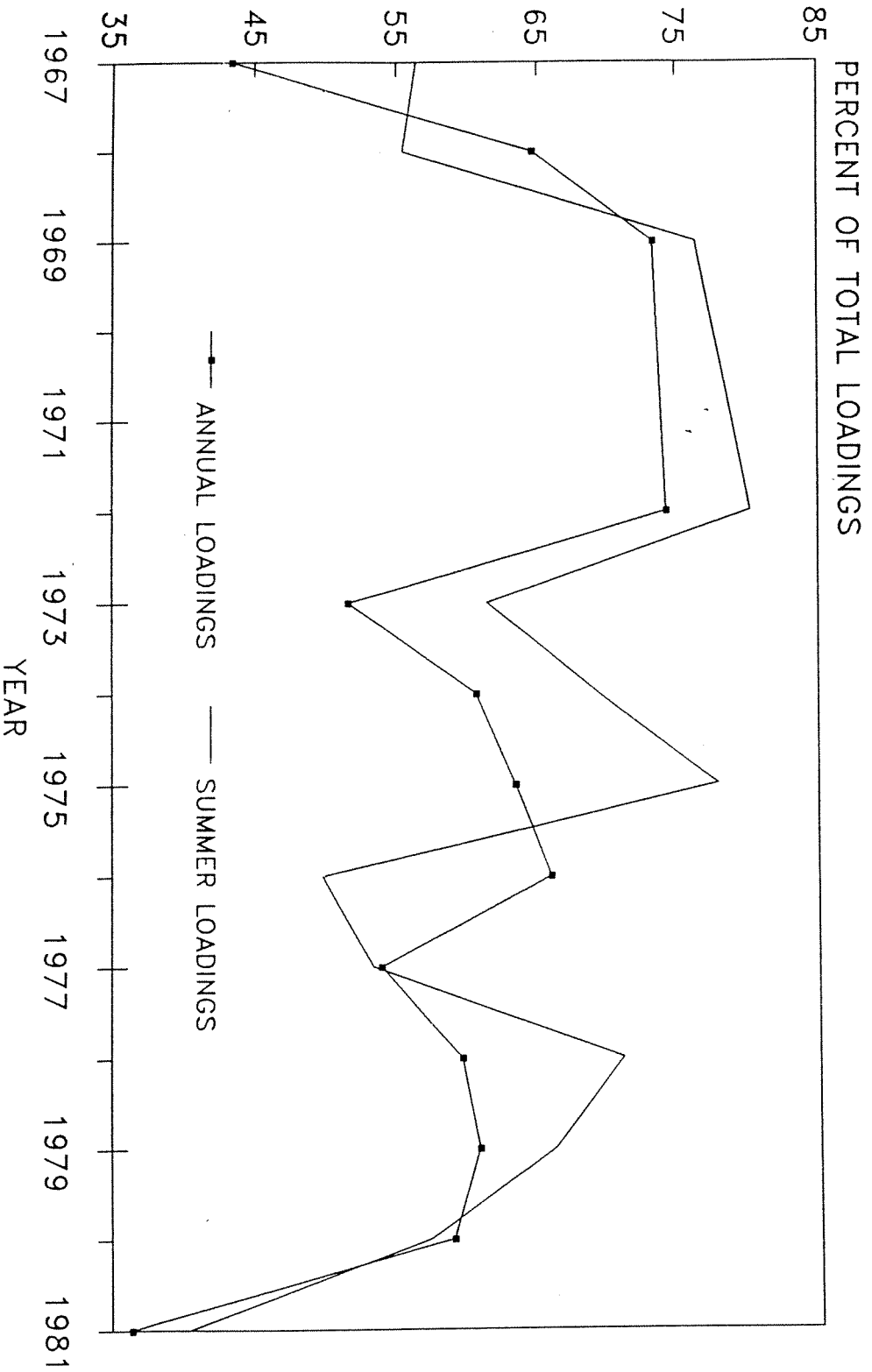

Source: Minns et al. (1986)

loadings follow similar patterns. The mean percentages were 59 percent for annual loadings, 63 percent for summer loadings. In 1972, the maximum percentages were recorded, 74 percent and 80 percent for annual and summer respectively.

Using the time series data, Minns et al.(1986) develop several flow diagrams that show the change over the pre-control vs. control periods (Figure 49). Some results from these diagrams are (i) the level of nitrogen inventories in the bay have declined significantly in the Upper Bay, (ii) sedimentation and reflux are generally of the same magnitude except in the Upper Bay, (iii) the Upper Bay has shifted toward greater nitrogen retention after P control, and (iv) point source nitrogen loadings have, on average, declined by a modest 10 percent (Minns et al., 1986 p.70).

6.2.3 The Presence of Toxic Substances in the Bay of Quinte

Unlike the RAP for Green Bay, the elimination of heavy metals and other contaminants in the Bay of Quinte has not been a primary concern of the preliminary RAP for the Bay of Quinte. As noted in the RAP progress report, there is limited information on the concentrations of these materials in the tributaries of the Bay of Quinte. Information that is available suggests that there may be occasional excessive concentrations of some materials but these are not long term trends (RAPCC, p.16).

There has been research on the presence of various substances in the sediments of the bay. Table 33 presents a comparison of the concentration of various heavy metals and PCPs at various locations across the bay for the year 1982. From this table we see that except for the metals arsenic and cadmium, the concentration of heavy metals and PCPs exceeded the Ontario Ministry of the Environment's open-water dredging disposal guidelines. The

Figure 49: Nitrogen Budgets, Bay of Quinte 1972-1981

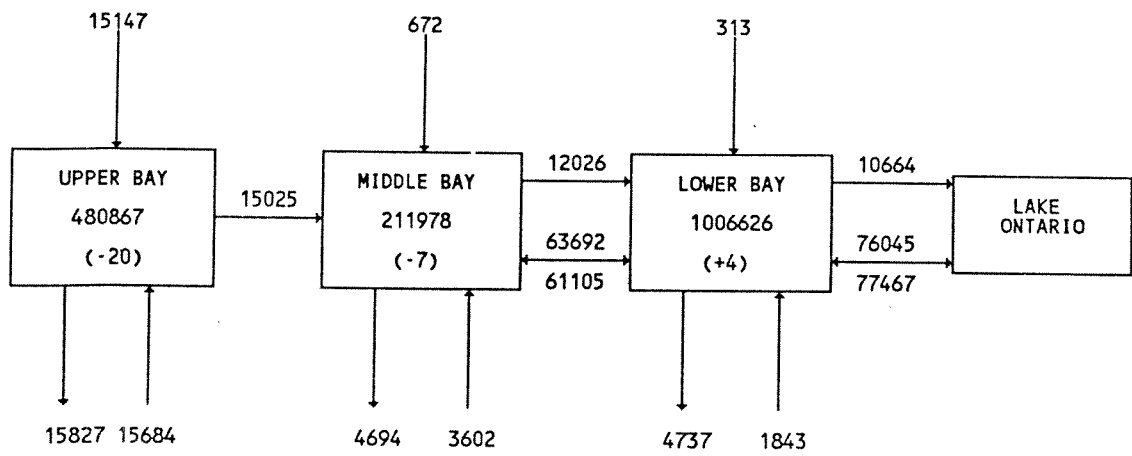

1972-1977 Annual Nitrogen Budget

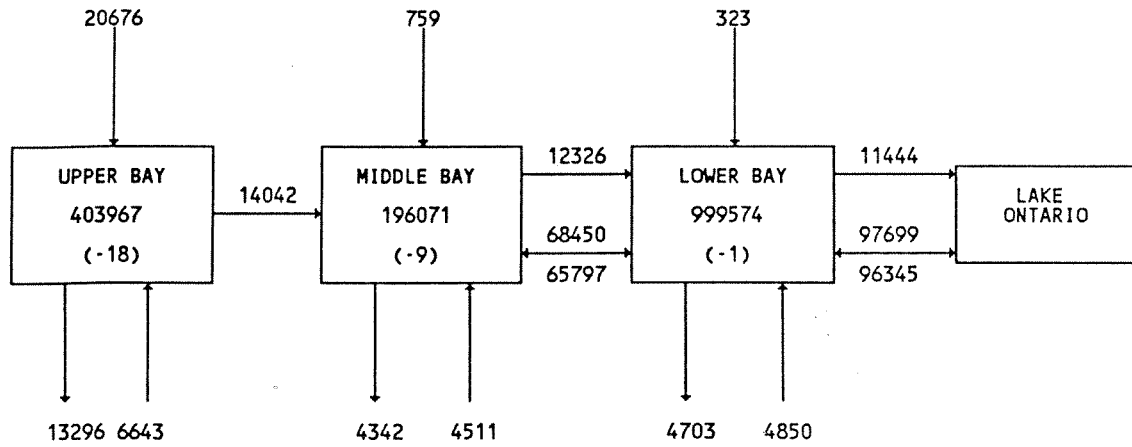

1978-1981 Annual Nitrogen Budget

Source: Minns et al. (1986)

Table 33. Mean Values of Heavy Metals (mg/l) and PCBs ($\mu\text{g/g}$) in Bay of Quinte Sediments-Variou Locations, 1982

Substance	Location				OME Standard
	Trenton	Belleville	Desoronto	Picton	
Arsenic	3.2	15.9	14.9	11.6	8.0
Cadmium	1.0	2.7	1.1	0.8	1.0
Chromium	59	64	48	60	25
Copper	35	62	35	37	25
Iron	18000	26400	26100	27400	10000
Mercury	0.33	0.56	0.34	0.19	0.30
Nickel	14	32	33	46	25
Lead	68	121	82	81	50
Zinc	150	272	197	171	100
PCBs	0.15	0.17	0.07	0.06	0.05

Source: Bay of Quinte RAP Coordinating Committee (1987), Table 5 p.21.

Note: OME Standard refers to the Ontario Ministry of Environment's Open-Water dredge disposal guidelines.

point being that in contrast to the heavy concentration of industry in the Lower Fox River and Green Bay areas, there are still concerns in the Bay of Quinte with respect to the loading of toxic substances.

VII. Cost of Further Rehabilitation of the Bay of Quinte

The previous discussion has provided an overview of historical and current fishery and water quality characteristics of the Bay of Quinte. In this section of the report we will be considering possible goals and objectives associated with future rehabilitative efforts there. As a starting point we will review possible goals and objectives as outlined by the Bay of Quinte RAP Coordinating Committee. We will then review preliminary cost estimates for achieving these objectives.

7.1 Key Concerns and Water Quality Goals for Rehabilitation of the Bay of Quinte

The Bay of Quinte RAP Coordinating Committee (RAPCC) in their 1987 progress report outline a series of key concerns associated with the rehabilitation of the bay. Table 34 provides a listing of these concerns. In regard to eutrophication, the RAPCC suggest that inspite of improvements in water quality due to reduced point source loadings and evidenced by less extensive algal blooms and improved water clarity, the plant and animal communities have not yet completely stabilized. As shown by Table 34, there are other concerns dealing with the level of toxic substances in the bay's sediments, the continued loss of fish and wildlife habitat, and the quality of the bay's fisheries.

Johnson (1986) provides a characterization of how to determine whether environmental quality in the bay is improving. The author states:

"Environmental quality improvement in the Bay of Quinte is assumed to mean reduction in frequency, duration and amplitude of algal blooms, increased diversity and moderate abundance of macrophytes, and better habitat for fish communities (for example, improved oxygen conditions, greater abundance of food chain functional phytoplankton, and optimum macrophyte stocks" (p.248).

Table 34. Key Concerns Affecting the Remedial Action Plan of the Bay of Quinte

-
- I. Eutrophication
 - (i) continued high levels of phosphorous from local sewage plants
 - (ii) current changes in limnology of the Bay of Quinte
 - (iii) determination of the appropriate methods for management of components of food chain
 - (iv) surface accumulation of blue-green algae
 - (v) quality of drinking water

 - II. Bacteriological Contamination
 - (i) effects on water-based recreation
 - (ii) current need to assess conditions

 - III. Contamination of Sediments
 - (i) heavy metals and PCB's exceeding provincial guidelines
 - (ii) heavy metals and PCB's incorporated into food chain by bottom feeders or by resuspension
 - (iii) need for further studies to determine presence of other pollutants and their impacts on ecosystem

 - IV. Loss of Fish and Wildlife Habitat

 - V. Quality of Commercial and Sport Fisheries
 - (i) lack of accurate information as to stock size and desirable harvest levels
 - (ii) lack of information as to desirable fish species
 - (iii) walleye sport fishery management plan
 - (iv) high contaminant levels of some fish
 - (v) lack of information with respect to economic value of the sport and commercial fishery

 - VI. Fish Contaminants
 - (i) some large size fish such as walleye and American eel are not safe for consumption
 - (ii) lack of information of sources of contamination

Source: Bay of Quinte RAP Coordinating Committee (1987)

In this regard the RAPCC has developed a set of goals by which environmental quality improvement could be obtained. These are listed in Table 35. Included in the variables listed are parameters dealing with water clarity, phosphorus concentrations, loading rates and composition of the phytoplankton present in the bay. When viewing this table, the RAPCC notes that these goals (except the point source phosphorus loadings) refer only to the Upper Bay and state that, "It is expected that proportional changes will materialize downstream in the Middle and Lower Bays, as determined by the morphometry and hydrology of these systems." (RAPCC, 1987 p.41). Secondly, they justify using May-October parameter values to measure improved environmental quality by stating that these values have historically provided reliable measures of lake enrichment.

7.2 Costs of Reducing Point Source Loadings to the Bay of Quinte

As noted above, the RAP process is not as advanced as that of the Green Bay RAP process. As such it was not possible to provide a detailed description of the costs estimates of achieving the various rehabilitation goals as was done with respect to the rehabilitation of Southern Green Bay. Cost estimates were, however, able to be obtained with respect costs of reducing further point source loadings of phosphorus. Table 36 lists recent estimates as to the costs of reducing municipal point source phosphorus loadings by 20 percent of current loadings. This reduction in loadings would be the result of imposing a 3 mg/L summer effluent limit on these facilities. The total capital costs of meeting this goal was estimated to be slightly less than \$10 million and annual operating costs of \$127,000.

Table 35. Current Water Quality Variable Values (May-October),
Upper Bay of Quinte and Interim Objectives

Parameter	Units	Current Value	Interim Objective
Point Source P Loading May-October (whole bay)	kg/d	48	30
Annual Point Source P Loading	kg/d	57	50
Total P Concentration	$\mu\text{g/L}$	52	30-35
Total N/P ratio	%	16	30
Phytoplankton			
(a) biomass	mm^3/L	11.9	4-5
	ASU/uL	6.2	2-3
(b) composition	%		
diatoms		65	50
blue-green algae		28	10
green algae		2	10
dinoflagellates		1	10
cryptomonads		3	10
chrysophytes		1	10
(c) chlorophyll a	$\mu\text{g/L}$	21	7-10
(d) Secchi disc	m	1.15	>1.8
(e) vertical light extinction	m	1.7	<1.4
Fecal Coliform (whole bay) #/ml			100/100ml
Wetland Habitat(whole bay) km^2		35	70

Source: Bay of Quinte RAP Coordinating Committee (1987),
Table 8 p.41.

Table 36. Costs of Achieving a 3 MG/L Phosphorus Point Source Summer Effluent Limit (1987 \$CDN)

WWTP	Cost (\$1000)	
	Capital	Annual Operating
Trenton	1,700	25
Belleville	3,700	55
Picton	810	10
Deseronto	350	5
Prince Edward	1,000	0
CFB Trenton	1,050	14
Napanee	1,200	18
Total	9,810	127

Source: CANVIRO (1988)

The costs of implementing the best available technology (BAT) at the industrial point source dischargers are presented in Table 37. As noted by CANVIRO (1988) the implementation of these technologies was not expected to have significant impacts on the point source phosphorus loadings. The authors did not mention the impacts on the loadings of heavy metals into the Bay. The capital costs of implementing the BAT was estimated to be \$4.7 million and annual operating costs of \$395,000.

7.3 On-Farm Costs of Reducing Agricultural Non-Point Phosphorous Loadings

Ecologistics (1988) conducted a study to evaluate the on-farm economic impacts of reducing the level of agriculturally related phosphorus loadings to the Bay of Quinte. Four small subwatershed areas which drain directly to the Bay of Quinte were chosen. Table 38 provides a general listing of the

Table 37. Costs of Implementing BAT at Industrial Point Source Dischargers to the Bay of Quinte (1987 \$CDN)

Point Source	Cost (\$1,000)	
	Capital	Annual Operating
Bakelite Themosets	1,100	175
Corby Distilleries	0	0
Domtar	500	120
Domtar Packaging	1,800	120
Trent Valley Paperboard	1,300	100
Total	4,700	395

Source: CANVIRO (1988)

Table 38. Characteristics of Watersheds Considered for the On-Farm Economic Analysis of Reduced Soil Erosion

Site	Location	Size (ha)	Physiographic Zone	Soils	Rotations Considered
1	SE of Frankfort	52	Clay Plain with Drumlins	-imperfectly to poorly drained clay-loam textured material (Elmbrook Clay) -sandy loam till on drumlins (Bondhead Sandy Loam)	1,3
2	E of Belleville	179	Till Plain	-imperfectly to well drained, loamy to silty loam textures with glacial till (Wampoo or Bondhead soil series with Sidney Clay in depressions)	1,3
3	Murray Hills	176	Drumlinized Till Plain	-well drained sandy loam (Bondhead Sandy Loam)	1,4
4	Cold Creek E of Wooler	106	Sand Plain	-well drained sandy loam (Brighton Sandy Loam)	1,2,3

Source: Ecologistics(1988)

^aThe numbers refer to the following rotations:

$$1 = 3H/2C^S$$

$$2 = 4H/2C^S$$

$$3 = 3H/2G/2C^G$$

$$4 = 2C/2B$$

where H = hay, B = Bean, C = corn, C^S = corn silage, C^G = corn grain, and G = small grain (winter wheat, oats). The assignment of rotations to each region was based on observed cropping practices in each region.

characteristics of the subwatersheds analyzed. The authors estimate regional loadings of suspended solids and phosphorus under two scenarios: (i) use of conventional tillage practices and (ii) use of conservation tillage. The conservation tillage practices analyzed included the use of chisel plows as well as no-till systems.

The authors assumed that a chisel plow system would be used in place of the moldboard plow for fall tillage operations in the hay-based rotations except during the establishment year. The no-till system was assumed to replace conventional tillage in the corn/soybean rotation in site 3 (Table 39). The authors estimate regional loadings under all conventional vs. all conservation tillage systems. The results of this comparison are presented in Table 39. In terms of phosphorus loadings, the adoption of no-till in the soybean rotation was predicted to reduce the region loading in site 3 by 65 percent. The range in other regions was from 37 to 54 percent depending on the rotation and region. Given this analysis the authors note the major shortcomings of extrapolating these results to all farmland in the Bay of Quinte watershed (Ecologistics, 1988 p.39). They then state that for planning purposes a 25 percent loading reduction could be considered a reasonable long term goal.

The question remains as to the on-farm costs of adopting the alternative tillage practices. A partial budgeting approach was used to assess the short-run economic impacts of soil conservation adoption. The analysis is short run in nature due to the fact that the impacts of alternative tillage practices on long-term soil productivity were not considered.

The authors develop two representative farms. Farms with hay rotations are assumed to have 100 acres of cropland, Cash grain operations were

Table 39. Delivery of Sediment (Tonnes) and Phosphorus (KG) to the Bay of Quinte Under Alternative Rotations, Tillage Practices, and Season, by Subwatershed Region

Site	Rotation	Season	Delivered Sediment				Delivered Phosphorus			
			Conventional		Conservation		Conventional		Conservation	
			Total	/HA	Total	/HA	Total	/HA	Total	/HA
1	3H/2C/2G	Spring	74.9	1.4	35.1	.7	89.5	1.7	49.2	1.0
		Summer	16.1	.3	10.0	.2	25.8	.5	17.6	.3
		Annual	271.0	5.2	123.9	2.4	251.2	4.9	135.2	2.6
	3H/2C	Spring	58.4	1.1	28.0	.5	73.5	1.4	41.1	.8
		Summer	10.8	.2	7.3	.1	18.7	.4	13.8	.3
		Annual	195.7	3.8	101.9	2.0	193.9	3.8	115.9	2.2
2	3H/2C/2G	Spring	40.3	.2	20.3	.1	69.0	.4	40.4	.2
		Summer	8.8	<.1	5.9	<.1	20.6	.1	15.2	.1
		Annual	147.7	.8	72.4	.4	195.9	1.1	112.6	.6
	3H/2C	Spring	32.0	.2	16.4	.1	57.6	.3	34.2	.2
		Summer	6.0	<.1	4.5	<.1	15.3	.1	12.2	.1
		Annual	108.2	.6	60.2	.3	153.8	.9	97.6	.5
3	3H/2C	Spring	508.7	2.9	241.4	1.4	457.2	2.6	261.6	1.5
		Summer	92.5	.5	4.5	.3	128.1	.7	92.2	.5
		Annual	1720.5	9.8	60.2	5.1	1382.2	7.9	271.3	4.8
	2C/2B	Spring	929.6	5.3	323.4	1.8	756.7	4.3	325.2	1.9
		Summer	402.0	2.3	84.3	.6	387.3	2.2	148.1	.8
		Annual	4372.3	24.9	1452.4	8.3	3332.5	19.0	1183.2	6.7
4	3H/2C/2G	Spring	331.5	3.1	143.4	1.4	328.3	3.1	168.5	1.6
		Summer	153.9	1.5	84.3	.8	172.5	1.6	107.1	1.0
		Annual	2170.6	20.6	913.4	8.6	1669.4	15.8	767.3	7.3
	3H/2C	Spring	253.7	2.4	112.4	1.1	264.7	2.5	139.0	1.3
		Summer	101.6	1.0	60.4	.6	124.1	1.2	82.3	.8
		Annual	1583.3	14.6	742.2	7.0	1219.9	11.6	641.0	6.1
	4H/2C	Spring	204.2	1.9	92.2	.9	222.9	2.1	118.9	1.1
		Summer	81.3	.8	50.7	.5	104.1	1.0	71.8	.7
		Annual	1237.8	11.7	606.8	5.7	1004.0	9.5	538.9	5.1

Source: Ecologistics (1988), Table II-5 and Table II-6.

assumed to have 200 acres of cropland. The following assumptions were used in calculating the net economic impacts:

- (i). The use of a chisel plow in the fall will depress corn yields by 5 percent for loam soils to 8 percent when the previous year was also corn,
- (ii). There is no yield impact in corn after hay when using a chisel plow, since a moldboard plow is assumed to be used to break the sod,
- (iii). The use of a chisel plow will not affect grain yields,
- (iv). Corn and bean yields are 5 percent lower with the no-till system,
- (v). Harvesting costs are not varied with yields,
- (vi). The following machinery is used:
 - a). a 8 ft. chisel plow is purchased for \$7,000 (\$cdn),
 - b). a four row no-till planter is purchased for \$13,000 (\$cdn), and
 - c). existing tillage equipment is retained.
- (vii). Equipment costs are based on an 11 percent interest rate and an annual operation time of 50 hours.
- (viii). Herbicide costs are increased 30 percent for the no-till system.
- (ix). No anhydrous ammonia is applied on corn after hay.

The resulting farm level economic impacts of adoption are presented in Table 40. The results show, that given the above assumptions, there is very little economic impact from adoption. The results presented here are dependent on the management skills of the adopters and as the authors note:

"Experience and management skills are particularly important with a no-till system. Estimated figures are more representative of crop trial results using planting equipment and weed control equipment that are no longer being used by innovators in the field. Improved planters and the timely use of post-emergent herbicides have actually cut herbicide costs and produced yields that are comparable to moldboard plow yields. If this experience of innovators in Southwestern Ontario is incorporated into the revenue calculations for the corn/soybean system, adoption of a no-till system then actually increases farm revenue by \$22/acre or \$4,400 for a 200 acre farm" (p.46).

Given the importance of nonpoint pollution in determining water quality in

the Bay of Quinte, the above results suggest that there may be little direct costs of changing farming practices. If society values improved water quality, financial incentives may be justified to be given to agricultural producers in the region in order to increase the adoption of the reduced tillage technologies. Given the lack of major costs of adoption these financial incentives may not need to be that great to stimulate adoption.

Table 40. Net On-Farm Economic Effects of Adoption of Conservation Tillage (1987 \$CDN)

Revenue		
Crop Type	Yield/Acre	Unit Value
Hay	3.0 tons	\$48/ton
Corn Grain	78 bu	\$3.21/bu
Corn Silage	10.7 tons	\$18.80/ton
Soybeans	28 bu	\$7.43/bu
Winter Wheat	43 bu	\$3.66/bu
Oats	53 bu	\$2.00/bu

Costs		
Rotation	Tillage System	
	Conventional	Conservation
3H/2C/2O	\$146	\$145
3H/2C/2WW	155	155
3H/2C	158	158
4H/2C	154	153
2C/2B	190	180

Net Returns		
Rotation	Tillage System	
	Conventional	Conservation
3H/2C/2O	\$ 4	\$ 3
3H/2C/2WW	9	7
3H/2C	9	7
4H/2C	10	9
2C/2B	40	38

Source: Ecologistics (1988)

Note: The net returns are calculated as the mean over the length of the rotation. "O" = oats and "WW" = winter wheat.

VIII. Conclusions

The main objective of this study was to update earlier cost estimates for the rehabilitation of two estuaries of the Great Lakes: Green Bay and the Bay of Quinte. We also provided, as background, an historical overview of both water quality and fishery characteristics for both areas.

Green Bay and the Bay of Quinte were chosen because they are good examples of Great Lakes estuarine ecosystems that have been heavily impacted by human activities. The Bay of Quinte is mainly affected by loadings of nutrients that cause excessive eutrophication. Because of the industrial and agricultural development that has occurred in its watershed, Southern Green Bay has been impacted by both nutrients and toxic substances, such as PCBs, mercury, and lead.

The choice of the Bay of Quinte and Green Bay for this study was fortuitous. Both bays have been designated as Areas of Concern by the International Joint Commission and the resulting process to prepare Remedial Action Plans has generated economic data that greatly aided our work. The RAP process for Southern Green Bay was much further along than the process for the Bay of Quinte when this project was initiated. As a result, more data were available for Green Bay. We have incorporated information from most of the reports generated as a result of the RAP processes prior to writing this report (December, 1988). As the RAP process continues in both regions, the cost estimates provided in this report could be updated.

As for the new costs associated with further rehabilitation of Green Bay, current estimates for new capital costs range from \$68 million to \$639 million depending on the type of remedial actions undertaken. Operation and maintenance costs could range from less than \$1 million to more than \$10

million. A detailed listing of alternative actions, priority levels, and associated costs were presented. No attempt has yet been made to reduce these figures to present values or otherwise account for the potential effects of interest costs on total costs.

Because of the type of pollutants that have impacted the Bay of Quinte, a large portion of the work there has been devoted to point and nonpoint phosphorus loadings. In terms of the seven municipal waste water treatment plants, the Bay of Quinte Remedial Action Plan Coordinating Committee (RAPCC) estimates that it would cost \$9.8 million (cdn.) in capital and \$127,000 (cdn.) in annual operating costs to achieve a 3 mg/l effluent goal. In terms of other point source dischargers into the bay, the RAPCC estimates that the costs of implementing the best available technology would be \$4.7 million (cdn.) in capital costs and \$395,000 in annual operating costs. The RAPCC has also conducted an analysis of the costs of implementing soil conserving tillage practices in the watershed that drains into the Bay of Quinte. Practicing conservation tillage would be one way to reduce the nonpoint source loadings of nutrients into the bay. The results of this research suggest that the farm level costs of adopting soil conservation practices would be small, if not zero. This has important implications for the provincial government in terms of the implementation of programs designed to promote the adoption of such technologies.²⁵ However, it should be noted that the political feasibility and the costs of farmer education programs and of the design and implementation of regulations on agricultural

²⁵An issue not addressed by the RAPCC study was the increased management required to implement soil conserving technologies. There may be indirect costs to farmers of improving their management skills so as to be able to maintain yields while using alternative tillage practices. These costs have not been included in the analysis of the impacts of adoption on net returns.

land use have yet to be examined.

In summary, the Bay of Quinte and Southern Green Bay contain ecosystems that have been severely impacted by human activities. Substantial progress has been made in rehabilitation in recent decades, but undesirable levels of eutrophication and, in the case of Green Bay, toxic contamination remain as major problems. Further rehabilitation is technically feasible, but will not be cheap. Future successes will depend on the willingness of governments--and ultimately on their respective constituents--to commit tens and perhaps even hundreds of millions of dollars to achieve ecosystem rehabilitati

Bibliography

- Ahrnsbrak, W.F. and Ragotzkie, R.A. "Mixing Processes in Green Bay", proceedings of the 13th Conference on Great Lakes Research, International Association of Great Lakes Research, 1973, p.880-890.
- Ball, J.R. V.A. Harris, D. Patterson. Lower Fox River, Depere to Green Bay Water Quality Standards Review, Wisconsin Department of Natural Resources, September 1985.
- Baldwin, N.S., R.W.Saalfeld, M.A.Ross, and H.J.Buettner. Commercial Fish Production in the Great Lakes 1867-1977, Great Lakes Fishery Commission, Technical Report No. 3, September 1979.
- Bay of Quinte Remedial Action Plan Coordinating Committee, Progress Report, Kingston, Ontario, 1987.
- Bertrand, G., J. Lang, and J. Ross. The Green Bay Watershed-Past, Present, Future, University of Wisconsin Sea Grant Technical Report #229, January 1976.
- Bishop, R.C., J. Cochrane, and J. Ives. Lake Michigan Salmonid Stocking Costs in Wisconsin, unpublished report, Department of Agricultural Economics, University of Wisconsin-Madison, 1989.
- Christie, W.J., A Review of the Changes in the Fish Species Composition of Lake Ontario, Great Lakes Fishery Commission Technical Report No. 23, 1973.
- CANVIRO Consultants. An Evaluation of Point Source Discharges to the Bay of Quinte Ecosystem, report submitted to the Bay of Quinte RAP Coordinating Committee, March 1988.
- Ecologistics Limited. Analysis of Agricultural Diffuse Source Loadings to the Bay of Quinte: A Bay of Quinte Remedial Action Plan Study, report prepared for the Ontario Ministry of the Environment, July 1988.
- Epstein, E., M. Bryons, D. Mezei, and D. Patterson. Lower Green Bay: An Evaluation of Existing and Historical Conditions, Environmental Protection Agency Report #EPA-905/9-74-006, June 1974.
- Francis, G.R. J.J. Magnuson, H.A. Regeir, and D.R. Talhelm. Rehabilitating Great Lakes Ecosystems, Great Lakes Fisheries Commission Technical Report #37, December 1979.
- Great Lakes Water Quality Board, Report on Great Lakes Water Quality. Report to the International Joint Commission, Kingston Ontario, 1985.
- Griffen, D.M. An Evaluation of Variables and Potential Management Strategies Influencing the Commercial Harvest of Yellow Perch (Perca flavescens) on Southern Green Bay, Lake Michigan, unpublished M.A. thesis, University of Wisconsin-Green Bay, 1979.

- Harris, H.J., P.E. Sager, S. Richman, V.A. Harris, and C.J. Yarborough. "Coupling Ecosystem Science with Management: A Great Lakes Perspective from Green Bay, Lake Michigan, USA", Environmental Management, 11(5):619-625, 1987.
- Harris, H.J., P.E. Sager, C.J. Yarborough, and H.J. Day. "Evolution of Water Resource Management: A Laurentian Great Lakes Case Study", International Journal of Environmental Studies, 29:53-70, 1987.
- Harris, H.J., D.R. Talhelm, J.J. Magnuson, and A.M. Forbes. Green Bay in the Future-A Rehabilitative Prospectus, Great Lakes Fisheries Commission Technical Report #38, September, 1982.
- Hurley, D.A., "Fish Populations of the Bay of Quinte, Lake Ontario, Before and After Phosphorus Control", in C.K. Minns, D.A. Hurley, and K.H. Nichols (ed.), Project Quinte: Point Source Phosphorous Control and Ecosystem Response in the Bay of Quinte, Lake Ontario, Special Publication, Canadian Journal of Fisheries and Aquatic Sciences, 86:201-214.
- Hurley, D.A. and W.J. Christie. "Depreciation of the Warmwater Fish Community in the Bay of Quinte, Lake Ontario", Journal of the Fisheries Research Board of Canada, 34:1849-1860, 1977.
- Johnson, M.G. "Phosphorous Loadings and Environmental Quality in the Bay of Quinte, Lake Ontario", in C.K. Minns, D.A. Hurley, and K.H. Nichols (ed.), Project Quinte: Point Source Phosphorous Control and Ecosystem Response in the Bay of Quinte, Lake Ontario, Special Publication, Canadian Journal of Fisheries and Aquatic Sciences, 86:247-258.
- Johnson, M.G. and G.E. Owen. "Nutrients and Nutrient Budgets in the Bay of Quinte, Lake Ontario", Journal of Water Pollution Control Federation, 43:836-853, 1971.
- Johnson, M.G. and D.A. Hurley. "Overview of Project Quinte - 1972-1982", in C.K. Minns, D.A. Hurley, and K.H. Nichols (ed.), Project Quinte: Point Source Phosphorous Control and Ecosystem Response in the Bay of Quinte, Lake Ontario, Special Publication, Canadian Journal of Fisheries and Aquatic Sciences, 1986.
- Kraft, C. Green Bays Yellow Perch Fishery, University of Wisconsin Sea Grant Institute, WIS-SG-82-425, 1982.
- Lockwood's Directory of the Paper and Allied Industries, Vance Publishing Corporation, New York, 1986.
- Loehr, T. and J. Prey, Wisconsin Pulp and Paper Mill Pollution Control Capital Expenditures, unpublished report, Wisconsin Department of Natural Resources, Bureau of Water Resources Management, September 1987.
- Milliman, S. The Economics of Resource Rehabilitation: An Empirical Application of Capital Theory to Fishery Management, unpublished Ph.D. dissertation, University of Wisconsin-Madison, 1985.

- Minns, C.K., D.A. Hurley, and K.H. Nichols (ed.), Project Quinte: Point Source Phosphorous Control and Ecosystem Response in the Bay of Quinte, Lake Ontario, Special Publication, Canadian Journal of Fisheries and Aquatic Sciences, 1986.
- Minns, C.K., G.E. Owen, and M.G. Johnson. "Nutrient Loads and Budgets in the Bay of Quinte, Lake Ontario", in C.K. Minns, D.A. Hurley, and K.H. Nichols (ed.), Project Quinte: Point Source Phosphorous Control and Ecosystem Response in the Bay of Quinte, Lake Ontario, Special Publication, Canadian Journal of Fisheries and Aquatic Sciences, 86:59-76.
- Minns, C.K. and D.A. Hurley. "Population Dynamics and Production of White Perch, *Morone americana*, in the Bay of Quinte, Lake Ontario", in C.K. Minns, D.A. Hurley, and K.H. Nichols (ed.), Project Quinte: Point Source Phosphorous Control and Ecosystem Response in the Bay of Quinte, Lake Ontario, Special Publication, Canadian Journal of Fisheries and Aquatic Sciences, 86:215-223.
- Minns, C.K., and M.G. Johnson. "Temporal Variation in the Nutrient Export of Rivers Draining into the Bay of Quinte, Ontario Canada", Water Resources Bulletin, 15:1061-1072, 1979.
- Ontario Ministry of Natural Resources. Ontario Commercial Fish Industry-Statistics on Landings, 1961-1965, Commercial Fish and Fur Branch, Division of Fish and Wildlife, Toronto, 1972.
- Ontario Ministry of Natural Resources. Ontario Commercial Fish Industry-Statistics on Landings, 1966-1970, Commercial Fish and Fur Branch, Division of Fish and Wildlife, Toronto, 1972.
- Ontario Ministry of Natural Resources. Ontario Commercial Fish Industry-Statistics on Landings, 1971-1975, Fisheries Branch, Division of Fish and Wildlife, Toronto, 1976.
- Ontario Ministry of Natural Resources. Ontario Commercial Fish Industry-Statistics on Landings, 1976-1980, Fisheries Branch, Division of Fish and Wildlife, Toronto, 1982.
- Ontario Ministry of Natural Resources. Unpublished Commercial Catch Statistics, Lake Ontario Fisheries Unit, Picton Ontario, 1988.
- Ready, R.C. "Cost Benefit Analysis Under Temporal Uncertainty", Unpublished Ph.D. dissertation, Department of Agricultural Economics, University of Wisconsin, Madison, 1988.
- Robinson, G.W. "Water Quality of the Bay of Quinte, Lake Ontario Before and After Reductions in Phosphorus Loading", in C.K. Minns, D.A. Hurley, and K.H. Nichols (ed.), Project Quinte: Point Source Phosphorous Control and Ecosystem Response in the Bay of Quinte, Lake Ontario, Special Publication, Canadian Journal of Fisheries and Aquatic Sciences, 86:50-58.
- Schaner, T. Bay of Quinte Creel Surveys, 1981-1986, report submitted to the

- Great Lakes Fishery Commission, Lake Ontario Committee Meeting, March 1987.
- Scott, W.B. and W.J. Christie. "The Invasion of the Lower Great Lakes by the White Perch , *Roccus Americanus* (Gmelin), Journal of the Fisheries Research Board of Canada, 20:1189-1195.
- Sridharan, N. and G.F. Lee. "Phosphorous Studies in Lower Green Bay, Lake Michigan", Journal of Water Pollution and Control, 46(4):684-696, 1974.
- Sullivan, J.R. and J.J. Delfino. A Select Inventory of Chemicals in Wisconsin's Lower Fox River Basin, University of Wisconsin Sea Grant Institute, WIS-SG-82-238, March 1982.
- Swackhamer, D.L. and D.E. Armstrong. "Distribution and Characterization of PCB's in Lake Michigan Water", Journal of Great Lakes Research, 13(1):24-36, 1987.
- University of Wisconsin Sea Grant Institute. The Fisheries of the Great Lakes, 1984-1986 Biennial Report, WIS-SG-86-148: May 1986.
- Wisconsin Department of Natural Resources. Building for Clean Water in Wisconsin: A Review of the Wisconsin Fund Construction Grants Program, Bureau of Water Grants, February, 1983.
- Wisconsin Department of Natural Resources. Lake Michigan Fisheries Management Plan, Administrative Report #25, March 1986.
- Wisconsin Department of Natural Resources. Nutrient and Eutrophication Management Technical Advisory Management Committee Report for the Lower Green Bay Remedial Action Plan, , Publ-WR-167 87, July 1987(a).
- Wisconsin Department of Natural Resources. Toxic Substances Management Technical Advisory Committee Report for the Lower Green Bay Remedial Action Plan, Publ-WR-166 87, July 1987(b).
- Wisconsin Department of Natural Resources. Biota and Habitat Management Technical Advisory Committee Report for the Lower Green Bay Remedial Action Plan, Publ-WR-165 87, July 1987(c).
- Wisconsin Department of Natural Resources. Lower Green Bay Remedial Action Plan, Publ-WR-175-87, September 1987(d).
- Wisconsin Department of Natural Resources, Grant Awards Report-Wisconsin Fund, unpublished data, Bureau of Water Resources Management, January 1988.
- Wisconsin Department of Natural Resources, Annual Summaries-WPDES, Bureau of Water Resources Management, 1974-1986.
- Wisconsin Paper Council, Paper News, Winter-Spring 1986.